

Economical, Compact, Plug-in Timer

- Time limit operation with automatic resetting.
- DIN size (36 × 36 mm), fits standard 8-pin sockets.
- Wide choice of supply voltages:
24, 100 to 120, 200 to 240 VAC, 12, 24 VDC.
- Dual LED indication for power and output statuses.
- Large transparent setting knob.
- Setting error rating almost matches that of a 48 × 48 timer.
- Conforms to UL and CSA, and meets CE marking requirements.



Ordering Information

Operation/resetting system	Time-limit contact	Mounting method	Rated time	Model
Time-limit operation/ self-resetting	SPDT	Surface mounting, flush mounting, and DIN track mounting	1 s, 3 s, 5 s, 10 s, 30 s, 60 s, 3 min, 5 min, 10 min, 30 min, 60 min, 3 hrs	H3JA-8A
	DPDT			H3JA-8C

Note: Specify the model number, supply voltage, and rated time when ordering.

Ex. H3JA-8A 100 to 120 VAC 1 s
└─── Rated time
└─── Supply voltage

■ Accessories (Order Separately)

Name/specifications		Models
Flush Mounting Adapter		Y92F-31
Mounting Track	50 cm (ℓ) × 7.3 mm (t)	PFP-50N
	1 m (ℓ) × 7.3 mm (t)	PFP-100N
	1 m (ℓ) × 16 mm (t)	PFP-100N2
End Plate		PFP-M
Spacer		PFP-S
Track Mounting/ Front Connecting Socket	8-pin	PF085A
Back Connecting Socket	8-pin	US08
	8-pin	P3G-08
	8-pin, finger safe type	P3G-08 with Y92A-48G (see note 1)
Hold-down Clip (see note 2)	For PF085A Socket	Y92H-6

Note: 1. Y92A-48G is a finger safe terminal cover which is attached to the P3G-08 Socket.

2. Hold-down Clips are sold in sets of two.

Specifications

■ Time Ranges

Rated time	Time range	Rated time	Time range
1 s	0.1 to 1 s	3 min	0.3 to 3 min
3 s	0.3 to 3 s	5 min	0.5 to 5 min
5 s	0.5 to 5 s	10 min	1 to 10 min
10 s	1 to 10 s	30 min	3 to 30 min
30 s	3 to 30 s	60 min	6 to 60 min
60 s	6 to 60 s	3 hrs	0.3 to 3 hrs

■ Ratings

Rated supply voltage	24, 100 to 120 or 200 to 240 VAC (50/60 Hz); 12, 24 VDC
Operating voltage range	85% to 110% of rated supply voltage
Power consumption	<p><u>H3JA-8A</u></p> <p>100 to 120 VAC: Approx. 2.6 VA (1.1 W) at 120 VAC 200 to 240 VAC: Approx. 5.0 VA (1.5 W) at 240 VAC 24 VAC: Approx. 1.0 VA (0.9 W) at 24 VAC 24 VDC: Approx. 0.8 W at 24 VDC 12 VDC: Approx. 0.5 W at 12 VDC</p> <p><u>H3JA-8C</u></p> <p>100 to 120 VAC: Approx. 2.4 VA (0.9 W) at 120 VAC 200 to 240 VAC: Approx. 4.1 VA (1.1 W) at 240 VAC 24 VAC: Approx. 1.2 VA (1.0 W) at 24 VAC 24 VDC: Approx. 0.8 W at 24 VDC</p>
Control outputs	H3JA-8A: 7 A at 250 VAC, resistive load H3JA-8C: 5 A at 250 VAC, resistive load

■ Characteristics

Accuracy of operating time	±2% max. (full scale)
Setting error	±7% max. (full scale) ±50 ms at 20°C
Influence of voltage	±2% max. (full scale)
Influence of temperature	±5% max. (full scale)
Insulation resistance	100 MΩ min. (at 500 VDC)
Dielectric strength	2,000 VAC, 50/60 Hz for 1 min (between current-carrying and non-current-carrying parts, and between contact-carrying and control circuit, and between contacts of different poles) 750 VAC, 50/60 Hz for 1 min (between non-continuous contacts: H3JA-8A) 1,000 VAC, 50/60 Hz for 1 min (between non-continuous contacts: H3JA-8C)
Impulse withstand voltage	3 kV (between power terminals) 4.5 kV (between current-carrying terminal and exposed non-current-carrying metal parts)
Noise immunity	±1.5 kV (between power terminals) and ±1.5 kV (between output terminals), square-wave noise by noise simulator (pulse width: 100 ns/1 μs, 1-ns rise)
Static immunity	Destruction: 8 kV Malfunction: 6 kV
Vibration resistance	Destruction: 10 to 55 Hz with 0.75-mm double amplitude in 3 directions for 1 hour each. Malfunction: 10 to 55 Hz with 0.5-mm double amplitude in 3 directions for 10 minutes each.
Shock resistance	Destruction: 1,000 m/s ² Malfunction: 100 m/s ²
Ambient temperature	Operating: -10°C to 55°C Storage: -25°C to 65°C
Ambient humidity	Operating: 35% to 85%
Life expectancy	H3JA-8A Mechanical: 10,000,000 operations min. Electrical: 60,000 operations min. (7 A resistive load at 250 VAC, 360 operations/h) H3JA-8C Mechanical: 10,000,000 operations min. Electrical: 100,000 operations min. (5 A resistive load at 250 VAC, 360 operations/h)
EMC	(EMI) Emission Enclosure: EN55011 Group 1 class B Emission AC Mains: EN55011 Group 1 class B Harmonic Current: EN61000-3-2 Voltage Fluctuation and Flickering: EN61000-3-3 (EMS) Immunity ESD: EN61000-4-2: 6 kV contact discharge (level 3) 8 kV air discharge (level 3) Immunity RF-interference from AM Radio Waves: EN61000-4-3: 10 V/m (80 MHz to 1 GHz) (level 3) Immunity Burst: EN61000-4-4: 2 kV power port and output port (level 3) 1 kV control port with capacitive clamp (level 3) Immunity Surge: EN61000-4-5: 2 kV common mode (level 3) 1 kV differential mode (level 3)
Approved standard	UL508 (See note.), CSA C22.2 No. 14, conforms to EN61812-1 (Pollution degree 2)
Case color	Light gray (Munsell 5Y7/1)
Degree of protection	IP40 (panel surface)
Weight	H3JA-8A: Approx. 50 g H3JA-8C: Approx. 60 g

Note: The surrounding air temperature (operating) is -10 to 40°C.

Engineering Data

H3JA-8A

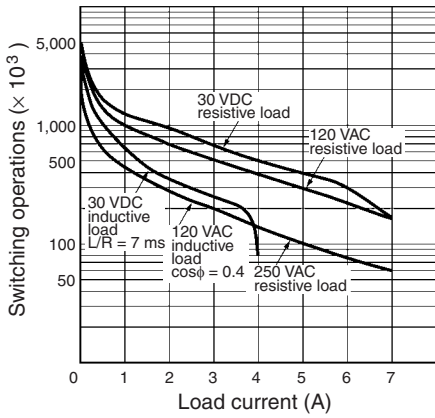

H3JA-8C

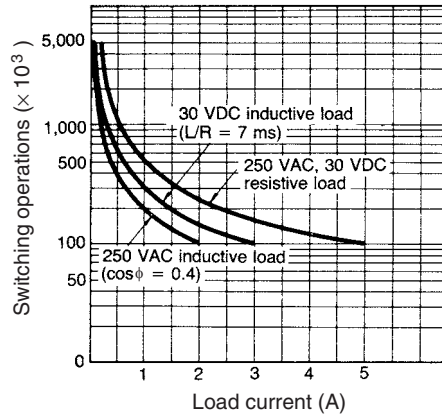

Operation

■ Timing Chart

H3JA-8A

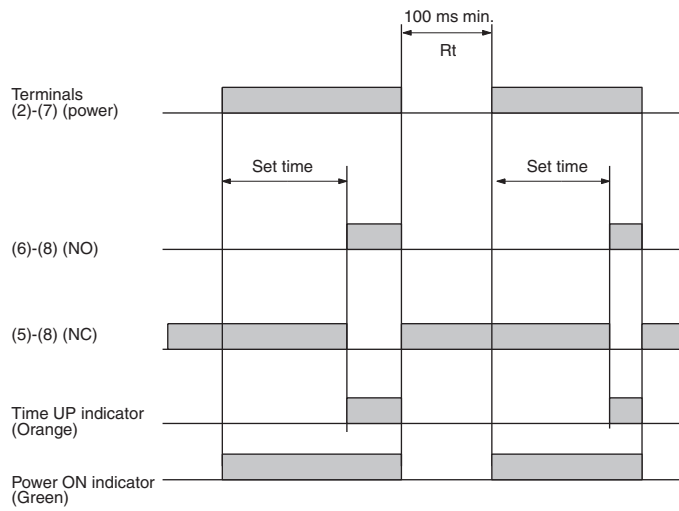

H3JA-8C

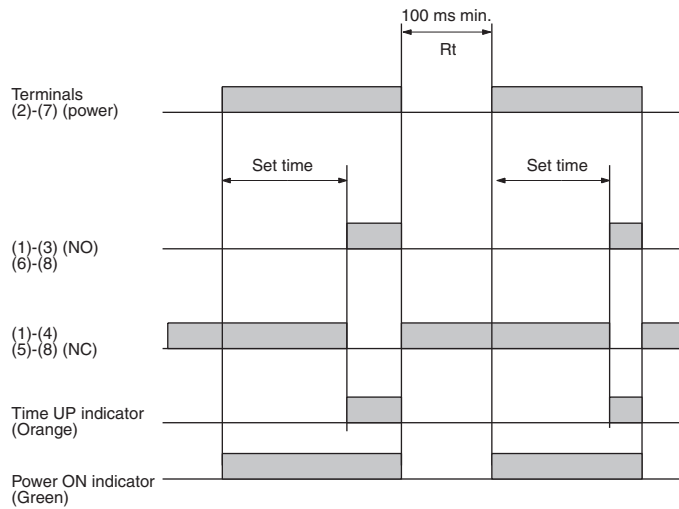

Dimensions

Note: All units are in millimeters unless otherwise indicated.

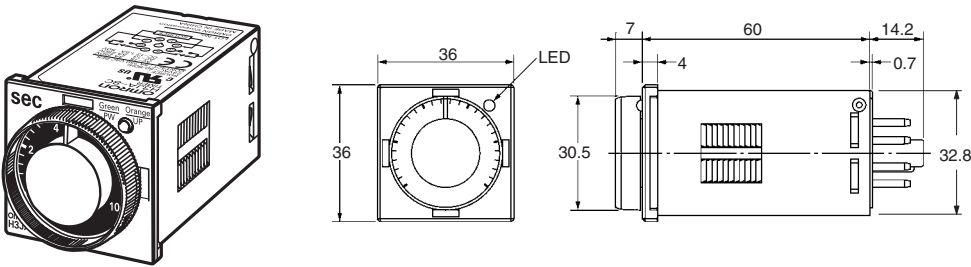

■ Accessories (Order Separately)

Flush Mounting Adapter

Y92F-31

Adapter Y92F-31 shown with H3JA-8□ and back connecting socket.

Panel Cutout

Recommended panel thickness: 1 to 5 mm

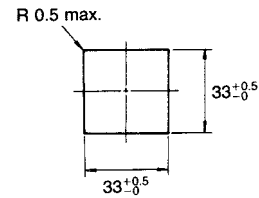
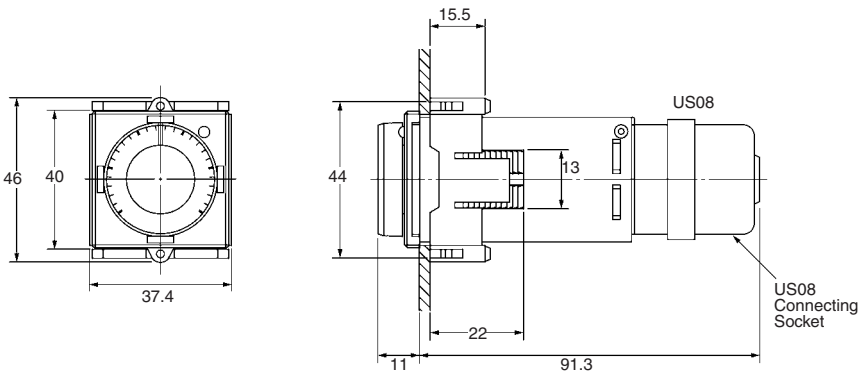

Track Mounting/Front Connecting Socket

PF085A

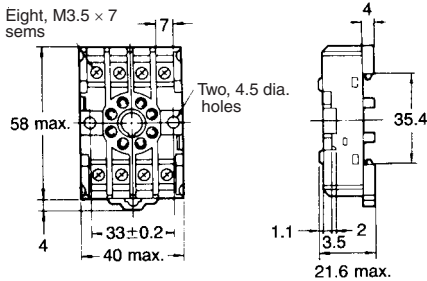

Terminal Arrangement (Top View)

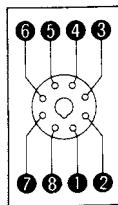

Mounting Holes

Two, M4 or 4.5 dia. holes

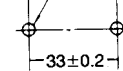

Mounting Height of Timer with Socket

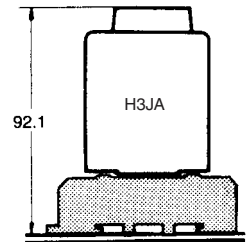

Note: PF085A can be used as a front connecting socket.

Hold-down Clips (Set of Two Clips)

Y92H-6 for PF085A Socket

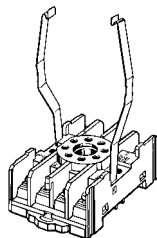
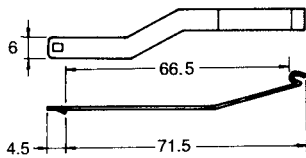

Back Connecting Socket

US08

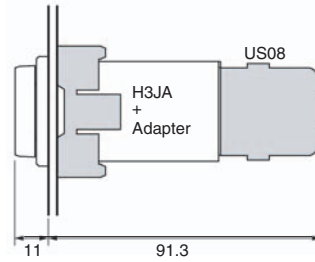
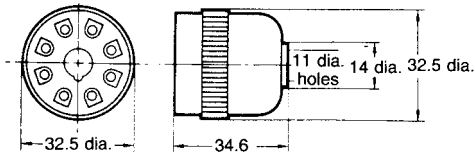

P3G-08

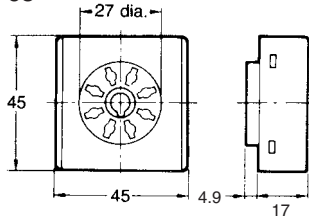

Terminal Arrangement (Bottom View)

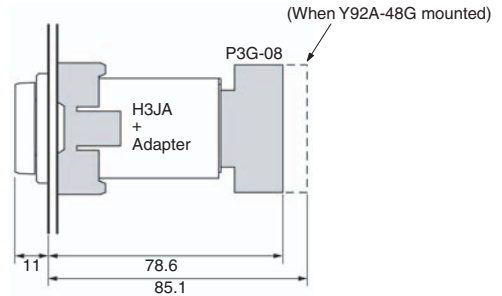
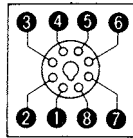

**Finger Safe Terminal Cover
Conforming to VDE0106/P100**

**Y92A-48G
(Attachment for P3G-08
Socket)**

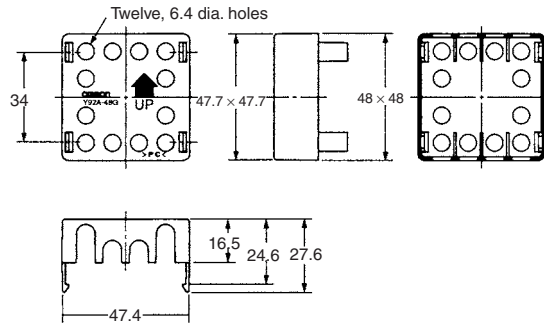
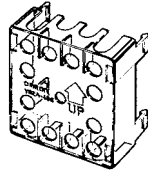

**Mounting Track
PFP-100N, PFP-50N**

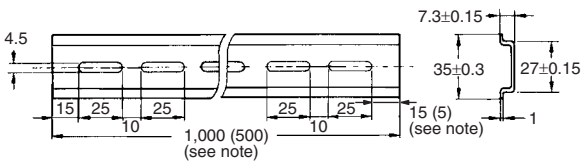
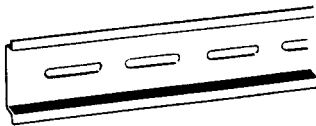

PFP-100N2

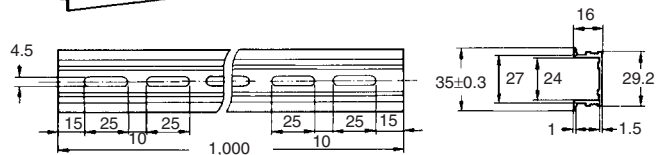
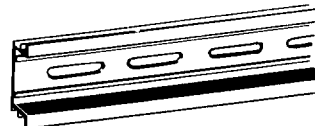

Note: The values shown in parentheses are for the PFP-50N.

End Plate
PFP-M

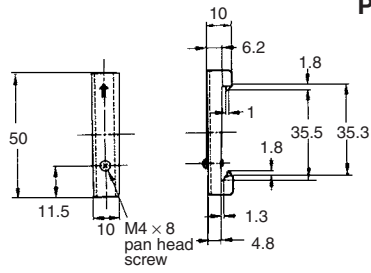
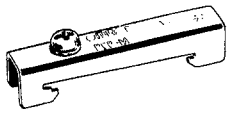

Spacer
PFP-S

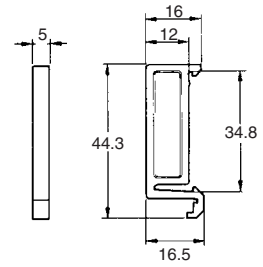
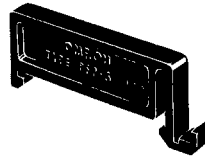

Installation

■ Terminal Arrangement

H3JA-8A

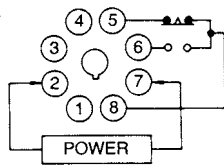

H3JA-8C

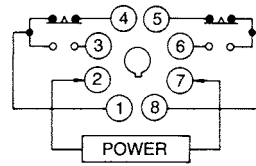

ALL DIMENSIONS SHOWN ARE IN MILLIMETERS.

To convert millimeters into inches, multiply by 0.03937. To convert grams into ounces, multiply by 0.03527.

Cat. No. L110-E1-01A **In the interest of product improvement, specifications are subject to change without notice.**

OMRON Corporation

Industrial Automation Company

Control Devices Division H.Q.

Analog Controller Division

Shiokoji Horikawa, Shimogyo-ku,

Kyoto, 600-8530 Japan

Tel: (81)75-344-7080/Fax: (81)75-344-7189

0707