

Digital Temperature Controllers/Digital Controllers E5□N/E5□N-H

Upgraded 1/16, 1/8, and 1/4 DIN Controllers, the Best-selling E5□N Series.
Basic Type (Renewal E5□N) and Advanced Type (New E5□N-H).

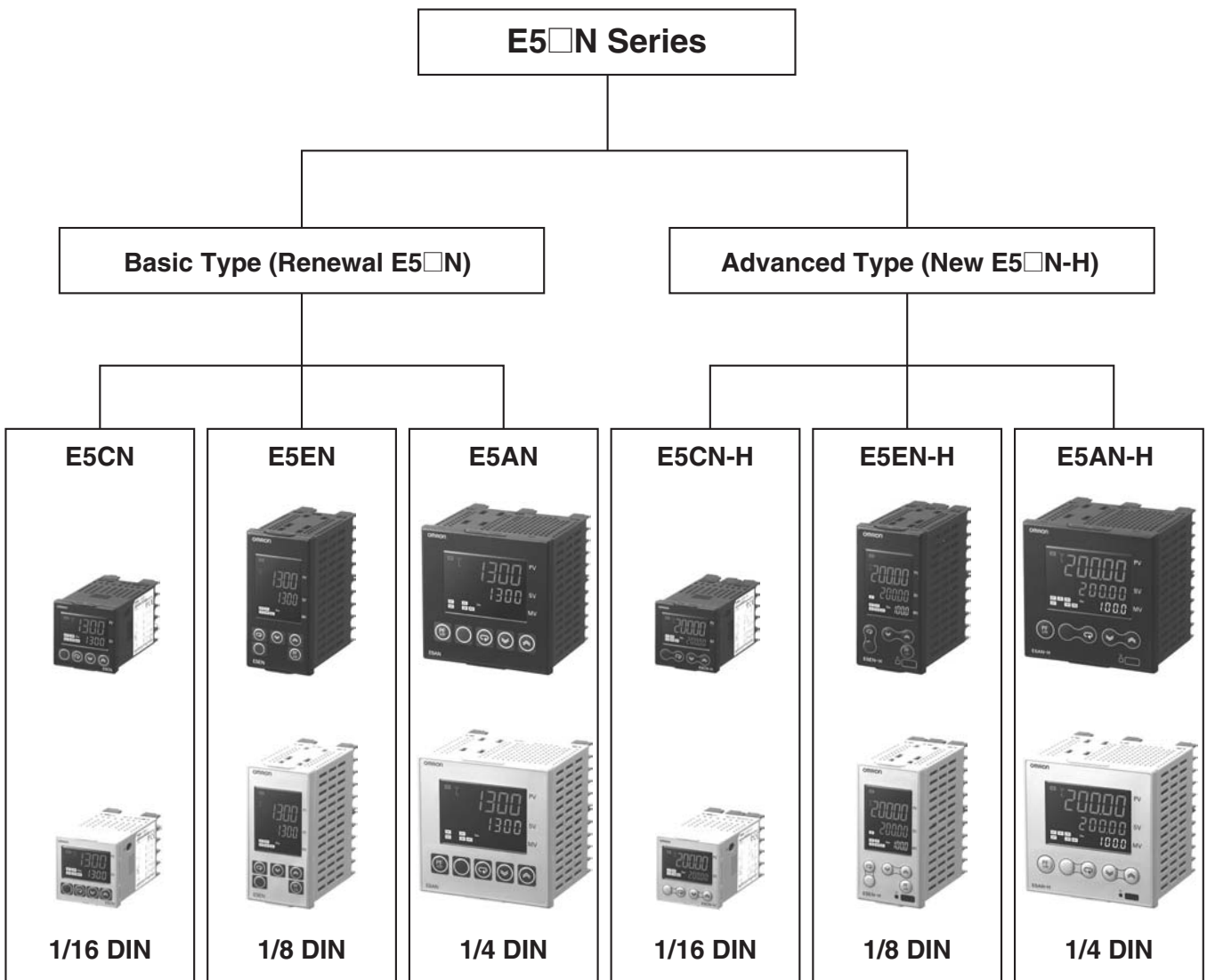

- Improved indication accuracy and preventive maintenance (Basic Type E5□N).
- New high-performance Controllers (Advanced Type E5□N-H).
- Easy-to-use one-touch operation with PF Key (Only for 1/8 and 1/4 DIN).
- Logic operations.



Contents

Digital Temperature Controllers	
E5CN/E5CN-U	3
E5AN/E5EN	17
Digital Controllers	
E5CN-H.....	31
E5AN-H/E5EN-H.....	43
Operation Procedure	
• Operation	58
Common to All Controllers	
• Safety Precautions	66
CX-Thermo Support Software	
• EST2-2C-MV4.....	70

Basic-type Digital Temperature Controller E5CN/E5CN-U (48 x 48 mm)

New 48 x 48-mm Basic Temperature Controller with Enhanced Functions and Performance. Improved Indication Accuracy and Preventive Maintenance Function.



- Indication Accuracy
 Thermocouple input: $\pm 0.3\%$ of PV (previous models: $\pm 0.5\%$)
 Pt input: $\pm 0.2\%$ of PV (previous models: $\pm 0.5\%$)
 Analog input: $\pm 0.2\%$ FS (previous models: $\pm 0.5\%$)
- New E5CN-U Models (Plug-in Models) with analog inputs and current outputs.
- A PV/SV-status display function can be set to automatically alternate between displaying the status of the Temperature Controller (auto/manual, RUN/STOP, and alarms) and the PV or SV.
- Preventive maintenance for relays in the Temperature Controller using a Control Output ON/OFF Counter.

NEW

Refer to *Safety Precautions* on page 66.

Main I/O Functions

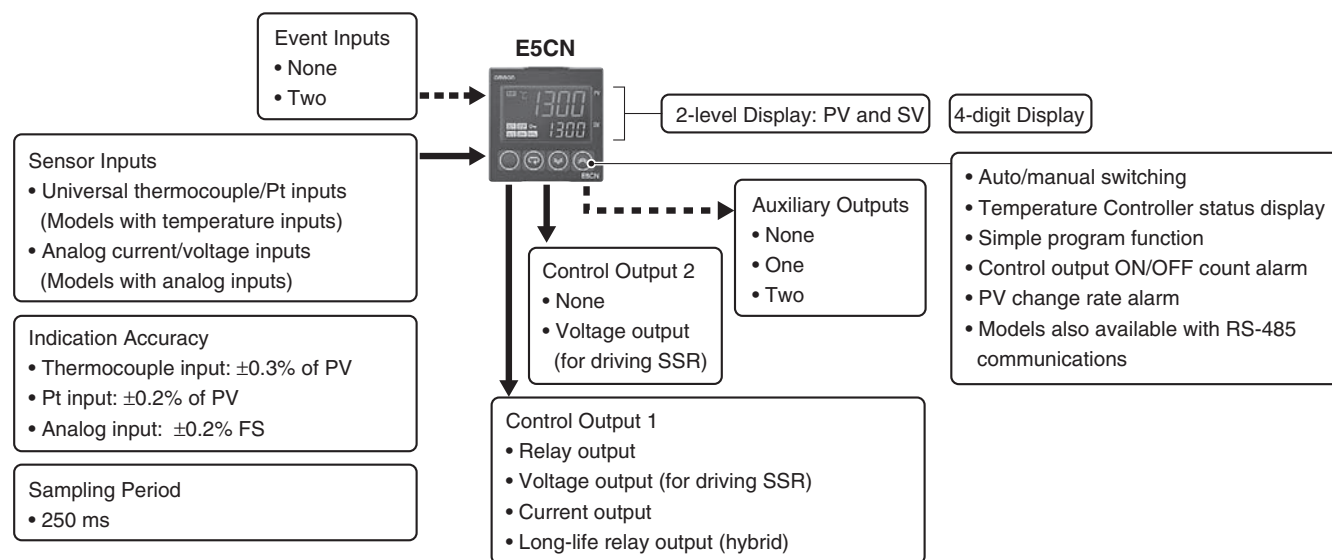

This data sheet is provided as a guideline for selecting products. Be sure to refer to the following user manuals for application precautions and other information required for operation before attempting to use the product.

E5CN/E5AN/E5EN Digital Temperature Controllers User's Manual Basic Type (Cat. No. H156)

E5CN/E5AN/E5EN Digital Temperature Controllers Communications Manual Basic Type (Cat. No. H158)

E5CN
E5CN-U (48 x 48 mm)

E5AN (96 x 96 mm)
E5EN (48 x 96 mm)

E5CN-H (48 x 48 mm)

E5AN-H (96 x 96 mm)
E5EN-H (48 x 96 mm)

Operation

Safety Precautions

E5CN/E5CN-U

Lineup

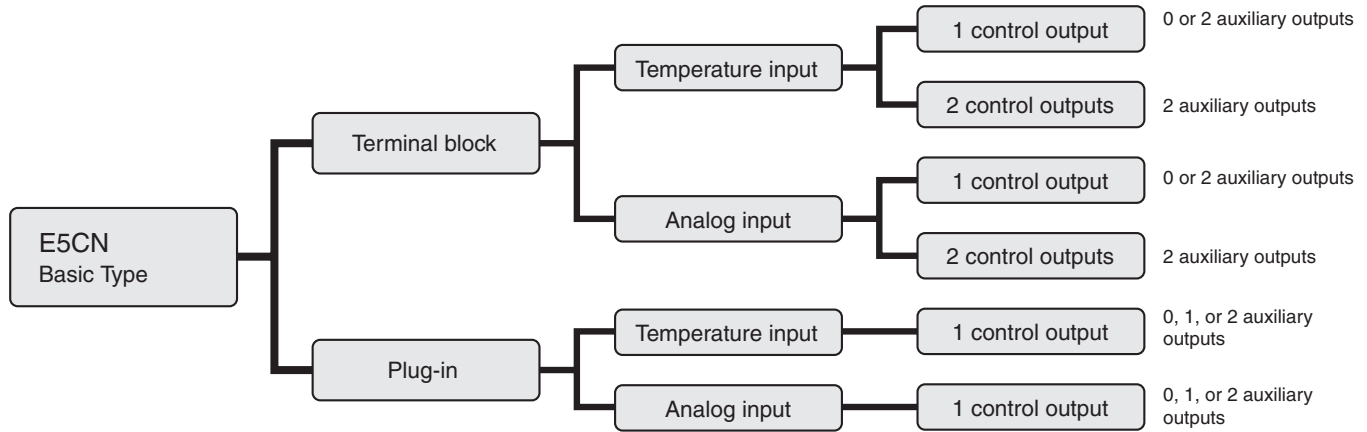

Note: Models with one control output and one or two auxiliary outputs and models with two control outputs can be used for heating/cooling control.

Model Number Structure

Model Number Legend

Controllers

E5CN-□□M□□-□-500
 1 2 3 4 5 6 7

- 1. Control Output 1**
 R: Relay output
 Q: Voltage output (for driving SSR)
 C: Current output
 Y: Long-life relay output (hybrid) *1
- 2. Auxiliary Outputs *2**
 Blank: None
 2: Two outputs
- 3. Option**
 M: Option Unit can be mounted.
- 4. Input Type**
 T: Universal thermocouple/platinum resistance thermometer
 L: Analog current/voltage input
- 5. Power Supply Voltage**
 Blank: 100 to 240 VAC
 D: 24 VAC/VDC
- 6. Case Color**
 Blank: Black
 W: Silver
- 7. Terminal Cover**
 -500: With terminal cover

Option Units

E53-CN□□□□
 1 2 3 4

- 1. Applicable Controller**
 CN: E5CN or E5CN-H
- 2. Function 1**
 Blank: None
 Q: Control output 2 (voltage for driving SSR)
 P: Power supply for sensor
- 3. Function 2**
 Blank: None
 H: Heater burnout/SSR failure/Heater overcurrent detection (CT1)
 HH: Heater burnout/SSR failure/Heater overcurrent detection (CT2)
 B: Two event inputs
 03: RS-485 communications
 H03: Heater burnout/SSR failure/Heater overcurrent detection (CT1) + RS-485 communications
 HB: Heater burnout/SSR failure/Heater overcurrent detection (CT1) + Two event inputs
 HH03: Heater burnout/SSR failure/Heater overcurrent detection (CT2) + RS-485 communications
- 4. Version**
 N2: Applicable only to models released after January 2008

Note: Not all combinations of function 1 and function 2 specifications are possible for Option Units (E53-□□□□).

*1. Always connect an AC load to a long-life relay output. The output will not turn OFF if a DC load is connected because a triac is used for switching the circuit. For details, check the conditions in *Ratings*.

*2. Auxiliary outputs are contact outputs that can be used to output alarms or results of logic operations.

E5CN (96 x 96 mm)
E5CN-U (48 x 48 mm)

E5AN (96 x 96 mm)
E5EN (48 x 96 mm)

E5CN-H (48 x 48 mm)

E5AN-H (96 x 96 mm)
E5EN-H (48 x 96 mm)

Operation

Safety Precautions

Ordering Information

Controllers with Terminal Blocks

Size	Case color	Power supply voltage	Input type	Auxiliary outputs	Control output 1	Model		
1/16 DIN 48 × 48 × 78 (W × H × D)	Black	100 to 240 VAC	Thermocouple or Resistance thermometer	None	Relay output	E5CN-RMT-500		
					Voltage output (for driving SSR)	E5CN-QMT-500		
					Current output	E5CN-CMT-500		
				2	Relay output	E5CN-R2MT-500		
					Voltage output (for driving SSR)	E5CN-Q2MT-500		
					Current output	E5CN-C2MT-500		
		24 VAC/VDC	Thermocouple or Resistance thermometer	None	Relay output	E5CN-RMTD-500		
					Voltage output (for driving SSR)	E5CN-QMTD-500		
					Current output	E5CN-CMTD-500		
				2	Relay output	E5CN-R2MTD-500		
					Voltage output (for driving SSR)	E5CN-Q2MTD-500		
					Current output	E5CN-C2MTD-500		
	Silver	100 to 240 VAC	Analog (current/voltage)	None	Relay output	E5CN-RML-500		
					Voltage output (for driving SSR)	E5CN-QML-500		
					Current output	E5CN-CML-500		
				2	Relay output	E5CN-R2ML-500		
					Voltage output (for driving SSR)	E5CN-Q2ML-500		
					Current output	E5CN-C2ML-500		
		24 VAC/VDC	Analog (current/voltage)	2	Relay output	E5CN-R2MLD-500		
					Voltage output (for driving SSR)	E5CN-Q2MLD-500		
					Current output	E5CN-C2MLD-500		
				100 to 240 VAC	Thermocouple or Resistance thermometer	None	Relay output	E5CN-RMT-W-500
							Voltage output (for driving SSR)	E5CN-QMT-W-500
							Current output	E5CN-CMT-W-500
2	Relay output	E5CN-R2MT-W-500						
	Voltage output (for driving SSR)	E5CN-Q2MT-W-500						
	Current output	E5CN-C2MT-W-500						
24 VAC/VDC	Thermocouple or Resistance thermometer	2	Long-life relay output (hybrid)	E5CN-Y2MT-W-500				
			Relay output	E5CN-R2MTD-W-500				
			Voltage output (for driving SSR)	E5CN-Q2MTD-W-500				
Current output	E5CN-C2MTD-W-500							

Option Units

One of the following Option Units can be mounted to provide the E5CN with additional functions.

Functions					Model
Communications RS-485	3-phase heater burnout/SSR failure/Heater overcurrent detection				E53-CNHH03N2
	Heater burnout/SSR failure/Heater overcurrent detection	Event inputs			E53-CNHB2
Communications RS-485			Control output 2 (Voltage for driving SSR)		E53-CNQ03N2
		Event inputs		External power supply for ES1B	E53-CNPBN2
	Heater burnout/SSR failure/Heater overcurrent detection			External power supply for ES1B	E53-CNPHN2
Communications RS-485				External power supply for ES1B	E53-CNP03N2
Communications RS-485	Heater burnout/SSR failure/Heater overcurrent detection				E53-CNH03N2
Communications RS-485					E53-CN03N2
		Event inputs			E53-CNBN2
	Heater burnout/SSR failure/Heater overcurrent detection		Control output 2 (Voltage for driving SSR)		E53-CNQH2
	3-phase heater burnout/SSR failure/Heater overcurrent detection		Control output 2 (Voltage for driving SSR)		E53-CNQH2N2
		Event inputs	Control output 2 (Voltage for driving SSR)		E53-CNQB2

Note: Option Units cannot be used for plug-in models.
These Option Units are applicable only to models released after January 2008.

E5CN
E5CN-U (48 x 48 mm)

E5AN (96 x 96 mm)
E5EN (48 x 96 mm)

E5CN-H (48 x 48 mm)

E5AN-H (96 x 96 mm)
E5EN-H (48 x 96 mm)

Operation

Safety Precautions

E5CN/E5CN-U

Model Number Structure

Model Number Legend (Plug-in-type Controllers)

E5CN-□□□□U
1 2 3 4

1. Output Type

- R: Relay output
- Q: Voltage output (for driving SSR)
- C: Current output

2. Number of Alarms

- Blank: No alarm
- 1: One alarm
- 2: Two alarms

3. Input Type

- T: Universal thermocouple/platinum resistance thermometer
- L: Analog Input

4. Plug-in type

- U: Plug-in type

Ordering Information

Plug-in-type Controllers

Size	Case color	Power supply voltage	Input type	Auxiliary outputs	Control output 1	Model	
1/16 DIN	Black	100 to 240 VAC	Thermocouple or resistance thermometer	None	Relay output	E5CN-RTU	
					Voltage output (for driving SSR)	E5CN-QTU	
					Current output	E5CN-CTU	
				1	Relay output	E5CN-R1TU	
					Voltage output (for driving SSR)	E5CN-Q1TU	
					Current output	E5CN-C1TU	
			2	Relay output	E5CN-R2TU		
				Voltage output (for driving SSR)	E5CN-Q2TU		
				Current output	E5CN-C2TU		
				Analog (current/voltage)	1	Relay output	E5CN-R1LU
						Voltage output (for driving SSR)	E5CN-Q1LU
						Current output	E5CN-C1LU
		2	Relay output		E5CN-R2LU		
			Voltage output (for driving SSR)		E5CN-Q2LU		
			Current output		E5CN-C2LU		
		24 VAC/VDC	Thermocouple or resistance thermometer	None	Relay output	E5CN-RTDU	
					Voltage output (for driving SSR)	E5CN-QTDU	
					Current output	E5CN-CTDU	
				1	Relay output	E5CN-R1TDU	
					Voltage output (for driving SSR)	E5CN-Q1TDU	
					Current output	E5CN-C1TDU	
			2	Relay output	E5CN-R2TDU		
				Voltage output (for driving SSR)	E5CN-Q2TDU		
				Current output	E5CN-C2TDU		

E5CN (48 x 48 mm)
E5CN-U (48 x 48 mm)

E5AN (96 x 96 mm)
E5EN (48 x 96 mm)

E5CN-H (48 x 48 mm)

E5AN-H (96 x 96 mm)
E5EN-H (48 x 96 mm)

Operation

Safety Precautions

Accessories (Order Separately)

USB-Serial Conversion Cable

Model
E58-CIFQ1

Terminal Cover

Connectable models	Terminal block models
Model	E53-COV17

Note: The Terminal Cover comes with the E5CN-□□□-500 models.

Waterproof Packing

Model
Y92S-29

Note: The Waterproof Packing is included with the Controller only for models with terminal blocks.

Current Transformers (CTs)

Hole diameter	Model
5.8 dia.	E54-CT1
12.0 dia.	E54-CT3

Adapter

Connectable models	Model
Terminal block models	Y92F-45

Note: Use this Adapter when the panel has been previously prepared for the E5B□.

Sockets (for Plug-in Models)

Type	Model
Front-connecting Socket	P2CF-11
Front-connecting Socket with Finger Protection	P2CF-11-E
Back-connecting Socket	P3GA-11
Terminal Cover for Back-connecting socket with Finger Protection	Y92A-48G

CX-Thermo Support Software

Model
EST2-2C-MV4

E5CN
E5CN-U (48 x 48 mm)

E5AN (96 x 96 mm)
E5EN (48 x 96 mm)

E5CN-H (48 x 48 mm)

E5AN-H (96 x 96 mm)
E5EN-H (48 x 96 mm)

Operation

Safety Precautions

E5CN/E5CN-U

Specifications

Ratings

Power supply voltage		No D in model number: 100 to 240 VAC, 50/60 Hz D in model number: 24 VAC, 50/60 Hz; 24 VDC	
Operating voltage range		85% to 110% of rated supply voltage	
Power consumption	E5CN	100 to 240 VAC: 7.5 VA (max.) (E5CN-R2T at 100 VAC: 3.0 VA) 24 VAC/VDC: 5 VA/3 W (max.) (E5CN-R2TD at 24 VAC: 2.7 VA)	
	E5CN-U	100 to 240 VAC: 6 VA (max.) 24 VAC/VDC: 3 VA/2 W (max.) (models with current output: 4 VA/2 W)	
Sensor input		Models with temperature inputs Thermocouple: K, J, T, E, L, U, N, R, S, B, W, or PL II Platinum resistance thermometer: Pt100 or JPt100 Infrared temperature sensor: 10 to 70°C, 60 to 120°C, 115 to 165°C, or 140 to 260°C Voltage input: 0 to 50 mV	
		Models with analog inputs Current input: 4 to 20 mA or 0 to 20 mA Voltage input: 1 to 5 V, 0 to 5 V, or 0 to 10 V	
Input impedance		Current input: 150 Ω max., Voltage input: 1 MΩ min. (Use a 1:1 connection when connecting the ES2-HB.)	
Control method		ON/OFF control or 2-PID control (with auto-tuning)	
Control outputs	Relay output	E5CN	SPST-NO, 250 VAC, 3 A (resistive load), electrical life: 100,000 operations, minimum applicable load: 5 V, 10 mA
		E5CN-U	SPDT, 250 VAC, 3 A (resistive load), electrical life: 100,000 operations, minimum applicable load: 5 V, 10 mA
	Voltage output (for driving SSR)	E5CN E5CN-U	Output voltage: 12 VDC ±15% (PNP), max. load current: 21 mA, with short-circuit protection circuit
	Current output	E5CN	4 to 20 mA DC/0 to 20 mA DC, load: 600 Ω max., resolution: approx. 10,000
Auxiliary outputs	Long-life relay output	E5CN	SPST-NO, 250 VAC, 3 A (resistive load), electrical life: 1,000,000 operations, load power supply voltage: 75 to 250 VAC (DC loads cannot be connected.), minimum applicable load: 5 V, 10 mA, leakage current: 5 mA max. (250 VAC, 60 Hz)
	Number of outputs	1 or 2 max. (Depends on the model.)	
Event inputs	Output specifications	Relay output: SPST-NO, 250 VAC, 3 A (resistive load), electrical life: 100,000 operations, minimum applicable load: 5 V, 10 mA	
	Number of inputs	2	
		External contact input specifications	Contact input: ON: 1 kΩ max., OFF: 100 kΩ min. Non-contact input: ON: Residual voltage: 1.5 V max., OFF: Leakage current: 0.1 mA max. Current flow: Approx. 7 mA per contact
External power supply for ES1B		12 VDC ±10%, 20 mA, short-circuit protection circuit provided	
Setting method		Digital setting using front panel keys	
Indication method		11-segment digital display and individual indicators (7-segment display also possible) Character height: PV: 11 mm, SV: 6.5 mm	
Multi SP		Up to four set points (SP0 to SP3) can be saved and selected using event inputs, key operations, or serial communications.	
Bank switching		Not supported	
Other functions		Manual output, heating/cooling control, loop burnout alarm, SP ramp, other alarm functions, heater burnout detection, 40% AT, 100% AT, MV limiter, input digital filter, self-tuning, temperature input shift, run/stop, protection functions, control output ON/OFF counter, extraction of square root, MV change rate limit, logic operations, PV/SV status display, simple program, automatic cooling coefficient adjustment	
Ambient operating temperature		-10 to 55°C (with no condensation or icing), for 3-year warranty: -10 to 50°C	
Ambient operating humidity		25% to 85%	
Storage temperature		-25 to 65°C (with no condensation or icing)	

E5CN (48 x 48 mm)
E5CN-U (48 x 48 mm)

E5AN (96 x 96 mm)
E5EN (48 x 96 mm)

E5CN-H (48 x 48 mm)

E5AN-H (96 x 96 mm)
E5EN-H (48 x 96 mm)

Operation

Safety Precautions

Alarm Outputs

Each alarm can be independently set to one of the following 13 alarm types. The default is 2: *Upper limit*. Auxiliary outputs are allocated for alarms. ON delays and OFF delays (0 to 999 s) can also be specified.

Note: For models with heater burnout, SSR failure, and heater overcurrent detection, alarm 1 will be an OR output of the alarm selected from the following alarm types and the alarms for heater burnout, SSR failure, and heater overcurrent. To output only a heater burnout alarm, SSR failure alarm, and heater overcurrent alarm for alarm 1, set the alarm type to 0 (i.e., no alarm function).

Set value	Alarm type	Alarm output operation	
		When X is positive	When X is negative
0	Alarm function OFF	Output OFF	
1 *1	Upper- and lower-limit		*2
2	Upper limit		
3	Lower limit		
4 *1	Upper- and lower-limit range		*3
5 *1	Upper- and lower-limit with standby sequence		*4
6	Upper-limit with standby sequence		
7	Lower-limit with standby sequence		
8	Absolute-value upper-limit		
9	Absolute-value lower-limit		
10	Absolute-value upper-limit with standby sequence		
11	Absolute-value lower-limit with standby sequence		
12	LBA (for alarm 1 only)	---	
13	PV change rate alarm	---	

*1. With set values 1, 4 and 5, the upper and lower limit values can be set independently for each alarm type, and are expressed as "L" and "H."

*2. Set value: 1, Upper- and lower-limit alarm

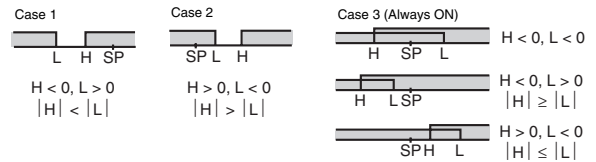

*3. Set value: 4, Upper- and lower-limit range

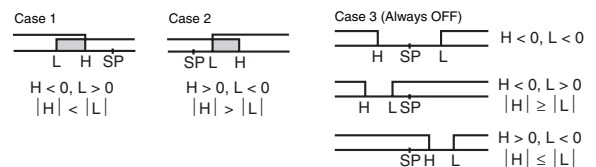

*4. Set value: 5, Upper- and lower-limit with standby sequence
For Upper- and Lower-Limit Alarm Described Above

- Case 1 and 2 Always OFF when the upper-limit and lower-limit hysteresis overlaps.
- Case 3: Always OFF

*5. Set value: 5, Upper- and lower-limit with standby sequence
Always OFF when the upper-limit and lower-limit hysteresis overlaps.

Characteristics

Indication accuracy		Thermocouple: *1 Terminal block models (E5CN): ($\pm 0.3\%$ of indicated value or $\pm 1^\circ\text{C}$, whichever is greater) ± 1 digit max. Plug-in models (E5CN-U): ($\pm 1\%$ of indicated value or $\pm 2^\circ\text{C}$, whichever is greater) ± 1 digit max. Platinum resistance thermometer input: Terminal block models (E5CN) and plug-in models (E5CN-U): ($\pm 0.2\%$ of indicated value or $\pm 0.8^\circ\text{C}$, whichever is greater) ± 1 digit max. Analog input: Terminal block models (E5CN) and plug-in models (E5CN-U): $\pm 0.2\%$ FS ± 1 digit max. CT input: Terminal block models (E5CN): $\pm 5\%$ FS ± 1 digit max.
Influence of temperature *2		Thermocouple input (R, S, B, W, PL II): Terminal block models (E5CN): ($\pm 1\%$ of PV or $\pm 10^\circ\text{C}$, whichever is greater) ± 1 digit max. Plug-in models (E5CN-U): ($\pm 2\%$ of PV or $\pm 10^\circ\text{C}$, whichever is greater) ± 1 digit max. Other thermocouple input: *3 Terminal block models (E5CN): ($\pm 1\%$ of PV or $\pm 4^\circ\text{C}$, whichever is greater) ± 1 digit max. Plug-in models (E5CN-U): ($\pm 2\%$ of PV or $\pm 4^\circ\text{C}$, whichever is greater) ± 1 digit max.
Influence of voltage *2		Platinum resistance thermometer input: Terminal block models (E5CN) and plug-in models (E5CN-U): ($\pm 1\%$ of PV or $\pm 2^\circ\text{C}$, whichever is greater) ± 1 digit max. Analog input: Terminal block models (E5CN) and plug-in models (E5CN-U): ($\pm 1\%$ FS) ± 1 digit max.
Input sampling period		250 ms
Hysteresis		Models with thermocouple/platinum resistance thermometer input (universal input): 0.1 to 999.9 EU (in units of 0.1 EU) *4 Models with analog input: 0.01 to 99.99% FS (in units of 0.01% FS)
Proportional band (P)		Models with thermocouple/platinum resistance thermometer input (universal input): 0.1 to 999.9 EU (in units of 0.1 EU) *4 Models with analog input: 0.1 to 999.9% FS (in units of 0.1% FS)
Integral time (I)		0 to 3999 s (in units of 1 s)
Derivative time (D)		0 to 3999 s (in units of 1 s) *5
Control period		0.5, 1 to 99 s (in units of 1 s)
Manual reset value		0.0 to 100.0% (in units of 0.1%)
Alarm setting range		-1999 to 9999 (decimal point position depends on input type)
Affect of signal source resistance		Thermocouple: $0.1^\circ\text{C}/\Omega$ max. (100 Ω max.) Platinum resistance thermometer: $0.1^\circ\text{C}/\Omega$ max. (10 Ω max.)
Insulation resistance		20 M Ω min. (at 500 VDC)
Dielectric strength		2,300 VAC, 50 or 60 Hz for 1 min (between terminals with different charge)
Vibration resistance	Malfunction	10 to 55 Hz, 20 m/s ² for 10 min each in X, Y, and Z directions
	Destruction	10 to 55 Hz, 0.75-mm single amplitude for 2 hrs each in X, Y, and Z directions
Shock resistance	Malfunction	100 m/s ² , 3 times each in X, Y, and Z directions
	Destruction	300 m/s ² , 3 times each in X, Y, and Z directions
Weight	E5CN	Controller: Approx. 150 g, Mounting Bracket: Approx. 10 g
	E5CN-U	Controller: Approx. 110 g, Mounting Bracket: Approx. 10 g
Degree of protection	E5CN	Front panel: IP66, Rear case: IP20, Terminals: IP00
	E5CN-U	Front panel: IP50, Rear case: IP20, Terminals: IP00
Memory protection		Non-volatile memory (number of writes: 1,000,000 times)
Setup Tool		CX-Thermo version 4.0 or higher
Setup Tool port		Provided on the bottom of the E5CN. Use this port to connect a computer to the E5CN when using the Setup Tool. An E58-CIFQ1 USB-Serial Conversion Cable is required to connect the computer to the E5CN. *6
Standards	Approved standards *7	UL 61010-1, CSA C22.2 No. 1010-1
	Conformed standards	EN 61010-1 (IEC 61010-1): Pollution level 2, overcurrent category II
EMC		EMI: Radiated Interference Electromagnetic Field Strength: EN 61326 Noise Terminal Voltage: EN 55011 Group 1, class A EMS: ESD Immunity: EN 61000-4-2 Electromagnetic Field Immunity: EN 61000-4-3 Burst Noise Immunity: EN 61000-4-4 Conducted Disturbance Immunity: EN 61000-4-6 Surge Immunity: EN 61000-4-5 Power Frequency Magnetic Field Immunity: EN 61000-4-8 Voltage Dip/Interrupting Immunity: EN 61000-4-11

*1. The indication accuracy of K thermocouples in the -200 to 1300°C range, T and N thermocouples at a temperature of -100°C max., and U and L thermocouples at any temperatures is $\pm 2^\circ\text{C} \pm 1$ digit max. The indication accuracy of the B thermocouple at a temperature of 400°C max. is not specified. The indication accuracy of B thermocouples in the 400 to 800°C range is $\pm 3^\circ\text{C}$ max. The indication accuracy of the R and S thermocouples at a temperature of 200°C max. is $\pm 3^\circ\text{C} \pm 1$ digit max. The indication accuracy of W thermocouples is ± 0.3 of PV or $\pm 3^\circ\text{C}$, whichever is greater, ± 1 digit max. The indication accuracy of PL II thermocouples is ± 0.3 of PV or $\pm 2^\circ\text{C}$, whichever is greater, ± 1 digit max.

*2. Ambient temperature: -10°C to 23°C to 55°C , Voltage range: -15% to 10% of rated voltage

*3. K thermocouple at -100°C max.: $\pm 10^\circ$ max.

*4. "EU" stands for Engineering Unit and is used as the unit after scaling. For a temperature sensor, the EU is $^\circ\text{C}$ or $^\circ\text{F}$.

*5. When robust tuning (RT) is ON, the differential time is 0.0 to 999.9 (in units of 0.1 s).

*6. External communications (RS-485) and cable communications for the Setup Tool can be used at the same time.

*7. The E5CN-U plug-in model is certified for UL listing only when used together with the OMRON P2CF-11 or P2CF-11-E Socket. The P3GA-11 is not certified for UL listing.

E5CN
E5CN-U (48 x 48 mm)E5AN (96 x 96 mm)
E5EN (48 x 96 mm)

E5CN-H (48 x 48 mm)

E5AN-H (96 x 96 mm)
E5EN-H (48 x 96 mm)

Operation

Safety Precautions

E5CN/E5CN-U

E5CN
E5CN-U (48 x 48 mm)

USB-Serial Conversion Cable

Applicable OS	Windows 2000, XP, or Vista
Applicable software	Thermo Mini, CX-Thermo version 4.0 or higher
Applicable models	E5AN/E5EN/E5CN/E5CN-U/E5AN-H/ E5EN-H/E5CN-H
USB interface standard	Conforms to USB Specification 1.1.
DTE speed	38400 bps
Connector specifications	Computer: USB (type A plug) Temperature Controller: Setup Tool port (on bottom of Controller)
Power supply	Bus power (Supplied from USB host controller.)
Power supply voltage	5 VDC
Current consumption	70 mA
Ambient operating temperature	0 to 55°C (with no condensation or icing)
Ambient operating humidity	10% to 80%
Storage temperature	-20 to 60°C (with no condensation or icing)
Storage humidity	10% to 80%
Altitude	2,000 m max.
Weight	Approx. 100 g

E5AN (96 x 96 mm)
E5EN (48 x 96 mm)

E5CN-H (48 x 48 mm)

Note: A driver must be installed in the personal computer. Refer to installation information in the operation manual for the Conversion Cable.

Communications Specifications

Transmission line connection method	RS-485: Multipoint
Communications	RS-485 (two-wire, half duplex)
Synchronization method	Start-stop synchronization
Protocol	CompoWay/F, SYSWAY, or Modbus
Baud rate	1200, 2400, 4800, 9600, 19200, 38400, or 57600 bps
Transmission code	ASCII
Data bit length *	7 or 8 bits
Stop bit length *	1 or 2 bits
Error detection	Vertical parity (none, even, odd) Frame check sequence (FCS) with SYSWAY Block check character (BCC) with CompoWay/F or CRC-16 Modbus
Flow control	None
Interface	RS-485
Retry function	None
Communications buffer	217 bytes
Communications response wait time	0 to 99 ms Default: 20 ms

E5AN-H (96 x 96 mm)
E5EN-H (48 x 96 mm)

Operation

Safety Precautions

* The baud rate, data bit length, stop bit length, and vertical parity can be individually set using the Communications Setting Level.

Current Transformer (Order Separately) Ratings

Dielectric strength	1,000 VAC for 1 min
Vibration resistance	50 Hz, 98 m/s ²
Weight	E54-CT1: Approx. 11.5 g, E54-CT3: Approx. 50 g
Accessories (E54-CT3 only)	Armatures (2) Plugs (2)

Heater Burnout Alarms, SSR Failure Alarms, and Heater Overcurrent Alarms

CT input (for heater current detection)	Models with detection for single-phase heaters: One input Models with detection for single-phase or three-phase heaters: Two inputs
Maximum heater current	50 A AC
Input current indication accuracy	±5% FS ±1 digit max.
Heater burnout alarm setting range *1	0.1 to 49.9 A (in units of 0.1 A) Minimum detection ON time: 100 ms
SSR failure alarm setting range *2	0.1 to 49.9 A (in units of 0.1 A) Minimum detection OFF time: 100 ms
Heater overcurrent alarm setting range *3	0.1 to 49.9 A (in units of 0.1 A) Minimum detection ON time: 100 ms

- *1. For heater burnout alarms, the heater current will be measured when the control output is ON, and the output assigned to the alarm 1 function will turn ON if the heater current is lower than the set value (i.e., heater burnout detection current value).
- *2. For SSR failure alarms, the heater current will be measured when the control output is OFF, and the output assigned to the alarm 1 function will turn ON if the heater current is higher than the set value (i.e., SSR failure detection current value).
- *3. For heater overcurrent alarms, the heater current will be measured when the control output is ON, and the output assigned to the alarm 1 function will turn ON if the heater current is higher than the set value (i.e., heater overcurrent detection current value).

Electrical Life Expectancy Curve for Relays (Reference Values)

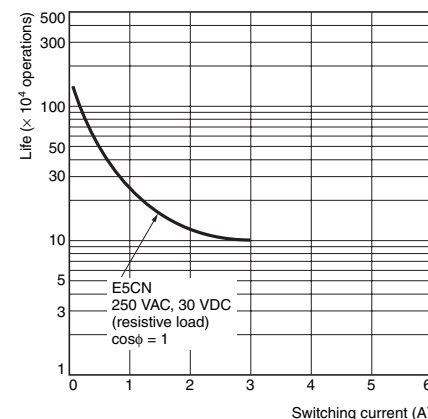

Note: Do not connect a DC load to a Controller with a Long-life Relay Output.

External Connections

- A voltage output (control output, for driving SSR) is not electrically insulated from the internal circuits. When using a grounding thermocouple, do not connect any of the control output terminals to ground. (If the control output terminals are connected to ground, errors will occur in the measured temperature values as a result of leakage current.)
- Consult with your OMRON representative before using the external power supply for the ES1B for any other purpose.

E5CN

Controllers

Control output 1
 Long-life relay output
 250 VAC, 3 A (resistive load)
 Relay output
 250 VAC, 3 A (resistive load)
 Voltage output (for driving SSR)
 12 VDC, 21 mA
 Current output
 0 to 20 mA DC
 4 to 20 mA DC
 Load: 600 Ω max.

Control output 2
 Voltage output (for driving SSR)
 12 VDC, 21 mA

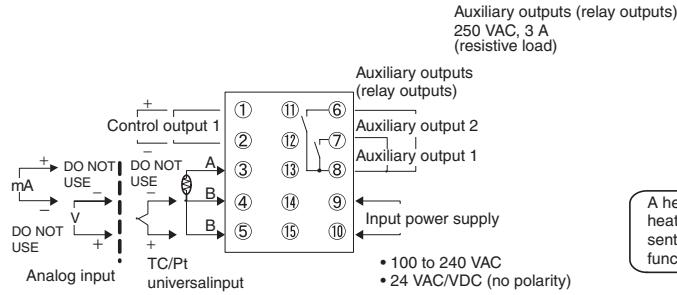

A heater burnout alarm, heater short alarm, heater overcurrent alarm, or input alarm is sent to the output to which the alarm 1 function is assigned.

Option Units

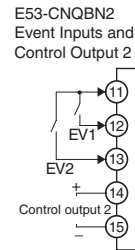
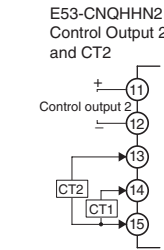
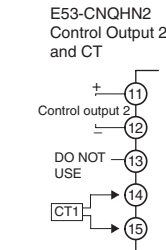
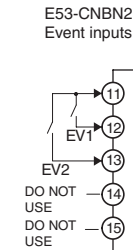
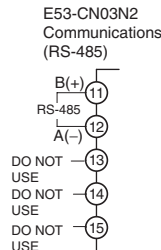
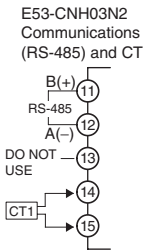
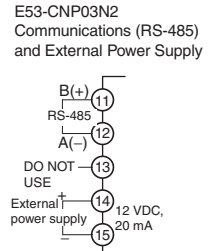
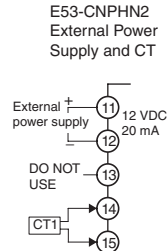
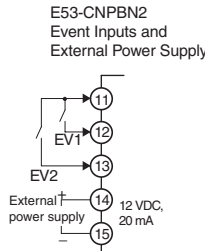
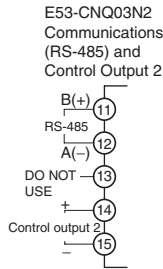
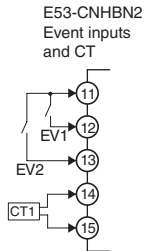
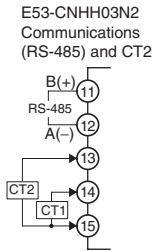

E5CN-U

Control output 1
 Relay output (three terminals used)
 SPDT, 250 VAC, 3 A (resistive load)
 Voltage output (for driving SSR)
 12 VDC, 21 mA
 Current output
 0 to 20 mA DC
 4 to 20 mA DC
 Load: 600 W max.

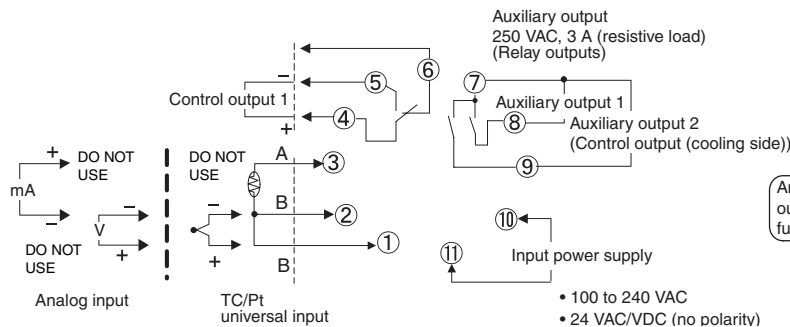

An input error is sent to the output to which the alarm 1 function is assigned.

Note: For the Wiring Socket, purchase the P2CF-11 or PG3A-11 separately.

E5CN
E5CN-U (48 x 48 mm)

E5AN (96 x 96 mm)
E5EN (48 x 96 mm)

E5CN-H (48 x 48 mm)

E5AN-H (96 x 96 mm)
E5EN-H (48 x 96 mm)

Operation

Safety Precautions

E5CN/E5CN-U

Nomenclature

E5CN E5CN-U

The front panel is the same for the E5CN and E5CN-U.

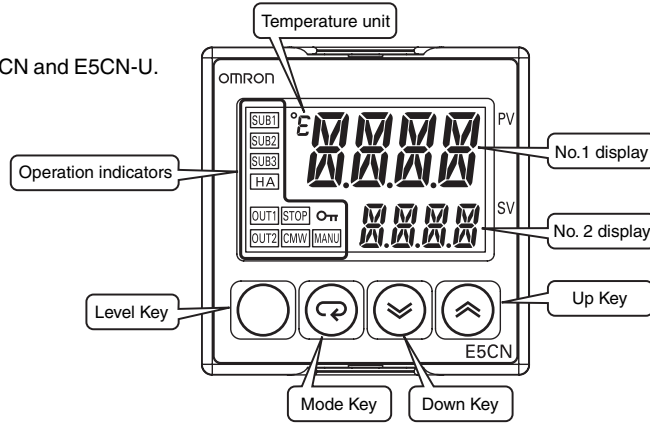

Dimensions

(Unit: mm)

E5CN Terminal Models

Panel Cutout

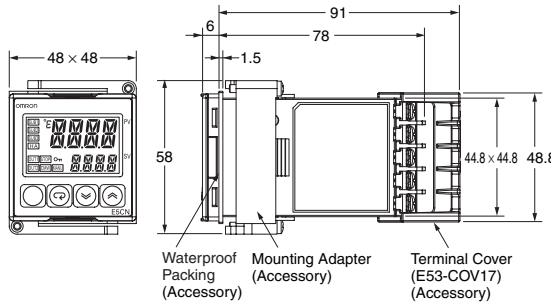

Mounted Separately

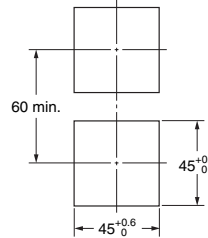

Group Mounted

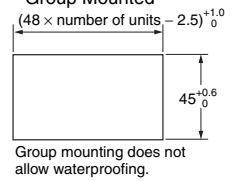

- Recommended panel thickness is 1 to 5 mm.
- Group mounting is not possible in the vertical direction. (Maintain the specified mounting space between Controllers.)
- To mount the Controller so that it is waterproof, insert the waterproof packing onto the Controller.
- When two or more Controllers are mounted, make sure that the surrounding temperature does not exceed the allowable operating temperature specified in the specifications.

Note: The terminal block cannot be removed.

E5CN-U Plug-in Models

Panel Cutout

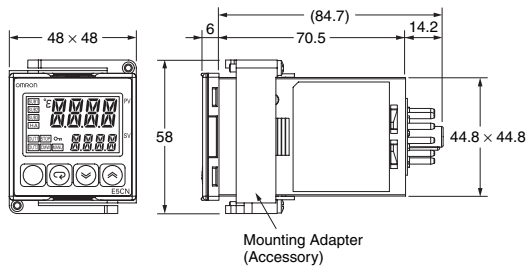

Mounted Separately

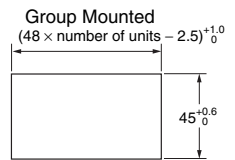
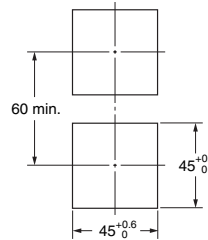

- Recommended panel thickness is 1 to 5 mm.
- Group mounting is not possible in the vertical direction. (Maintain the specified mounting space between Controllers.)
- When two or more Controllers are mounted, make sure that the surrounding temperature does not exceed the allowable operating temperature specified in the specifications.

Accessories (Order Separately)

USB-Serial Conversion Cable

E58-CIFQ1

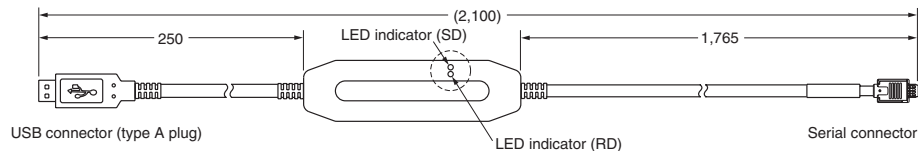
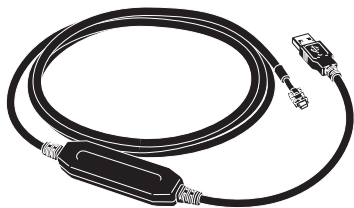

Operation

Safety Precautions

Terminal Cover E53-COV17

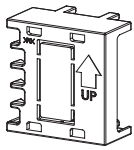

Note: The E53-COV10 cannot be used.

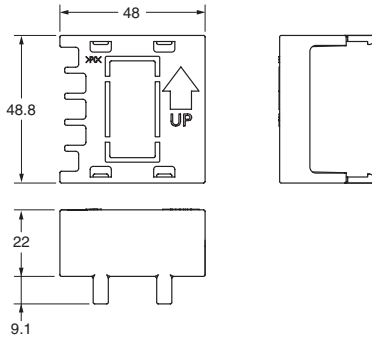

Waterproof Packing Y92S-29 (for DIN 48 × 48)

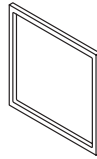

Order the Waterproof Packing separately if it becomes lost or damaged.
The Waterproof Packing can be used to achieve an IP66 degree of protection.
(Deterioration, shrinking, or hardening of the waterproof packing may occur depending on the operating environment. Therefore, periodic replacement is recommended to ensure the level of waterproofing specified in IP66. The time for periodic replacement depends on the operating environment. Be sure to confirm this point at your site. Consider one year a rough standard. OMRON shall not be liable for the level of water resistance if the customer does not perform periodic replacement.)
The Waterproof Packing does not need to be attached if a waterproof structure is not required.

Current Transformers

E54-CT1

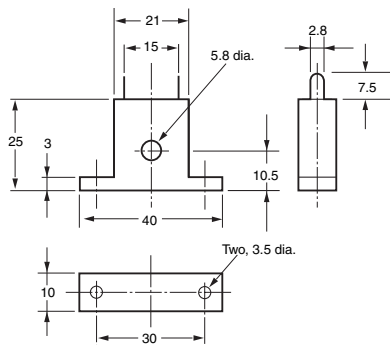
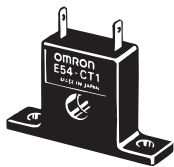

E54-CT1

Thru-current (I_o) vs. Output Voltage (E_o) (Reference Values)

Maximum continuous heater current: 50 A (50/60 Hz)
Number of windings: 400±2
Winding resistance: 18±2 Ω

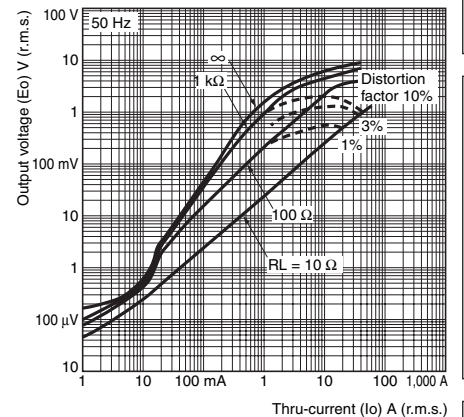

E54-CT3

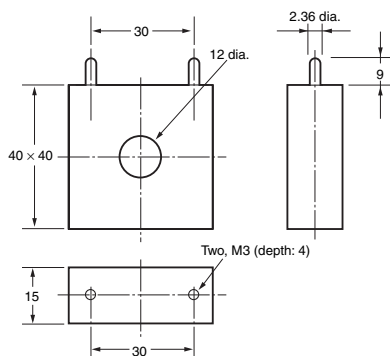

E54-CT3

Thru-current (I_o) vs. Output Voltage (E_o) (Reference Values)

Maximum continuous heater current: 120 A (50/60 Hz)
(Maximum continuous heater current for the Temperature Controller is 50 A.)
Number of windings: 400±2
Winding resistance: 8±0.8 Ω

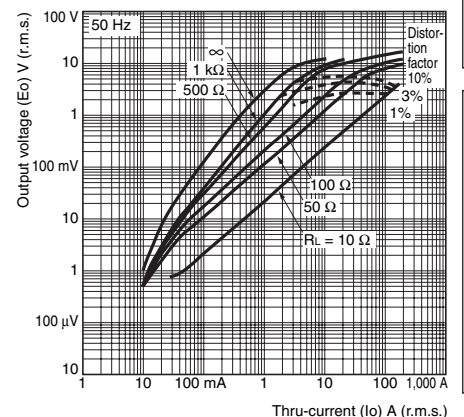

E54-CT3 Accessory

• Armature

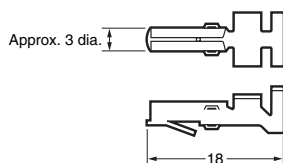

• Plug

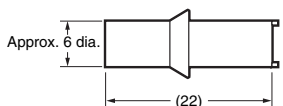

Connection Example

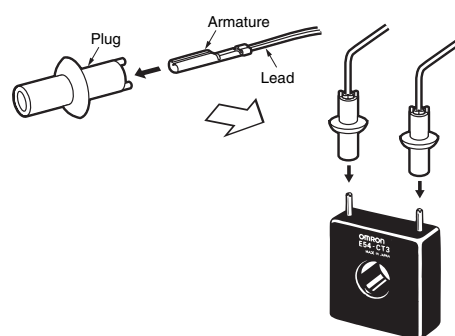

E5CN
E5CN-U (48 x 48 mm)

E5AN (96 x 96 mm)
E5EN (48 x 96 mm)

E5CN-H (48 x 48 mm)

E5AN-H (96 x 96 mm)
E5EN-H (48 x 96 mm)

Operation

Safety Precautions

E5CN/E5CN-U

Adapter

Y92F-45 Note: Use this Adapter when the panel has already been prepared for the E5B□.

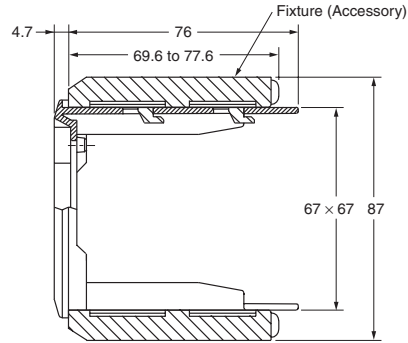
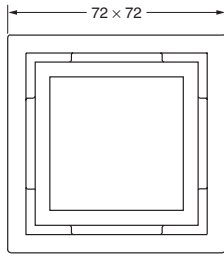
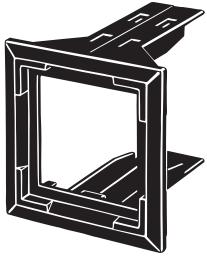

Mounted to E5CN

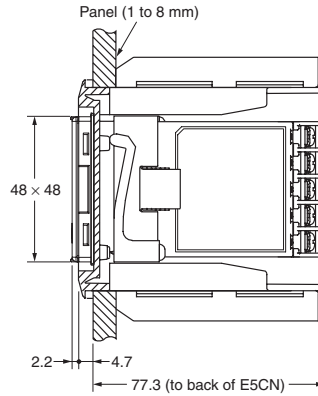
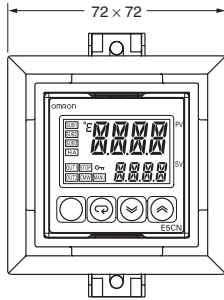
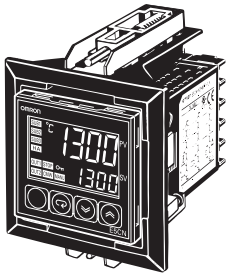

E5CN-U Wiring Socket

Front-connecting Socket

P2CF-11

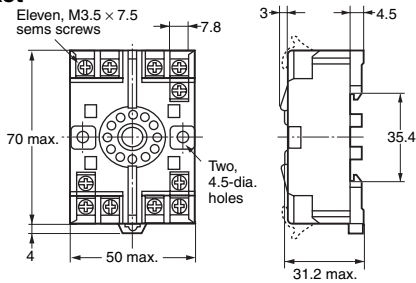
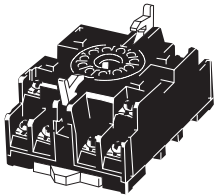

Terminal Layout/Internal Connections (Top View)

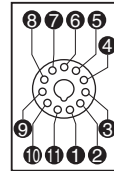

Mounting Holes

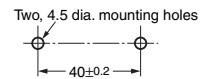

Note: Can also be mounted to a DIN track.

Note: A model with finger protection (P2CF-11-E) is also available.

Back-connecting Socket

P3GA-11

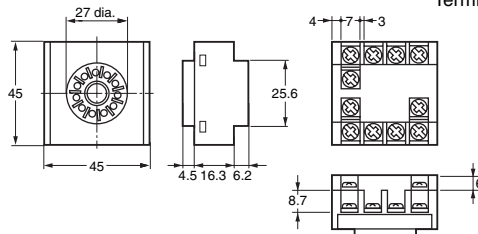
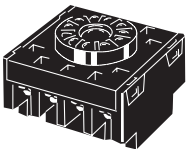

Terminal Layout/Internal Connections (Bottom View)

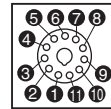

Note: 1. Using any other sockets will adversely affect accuracy. Use only the specified sockets.

2. A Protective Cover for finger protection (Y92A-48G) is also available.

E5CN (96 x 96 mm)
E5CN-U (48 x 48 mm)

E5AN (96 x 96 mm)
E5EN (48 x 96 mm)

E5CN-H (48 x 48 mm)

E5AN-H (96 x 96 mm)
E5EN-H (48 x 96 mm)

Operation

Safety Precautions

Basic-type Digital Temperature Controller

E5AN/E5EN (96 x 96 mm and 48 x 96 mm)

New 96 x 96-mm and 48 x 96-mm Basic Temperature Controllers with Enhanced Functions and Performance. Improved Indication Accuracy and Preventive Maintenance Function.



- Indication Accuracy
 - Thermocouple input: $\pm 0.3\%$ of PV (previous models: $\pm 0.5\%$)
 - Pt input: $\pm 0.2\%$ of PV (previous models: $\pm 0.5\%$)
 - Analog input: $\pm 0.2\%$ FS (previous models: $\pm 0.5\%$)
- A PV/SV-status display function can be set to automatically alternate between displaying the status of the Temperature Controller (auto/manual, RUN/STOP, and alarms) and the PV or SV.
- Preventive maintenance for relays in the Temperature Controller using a Control Output ON/OFF Counter.
- Three-level display that simultaneously displays the PV, SV, and MV.
- One-touch operation with PF Key that can be assigned to auto/manual, RUN/STOP, or other functions.



96 × 96 mm
E5AN

48 × 96 mm
E5EN

NEW

Refer to *Safety Precautions* on page 66.

Main I/O Functions

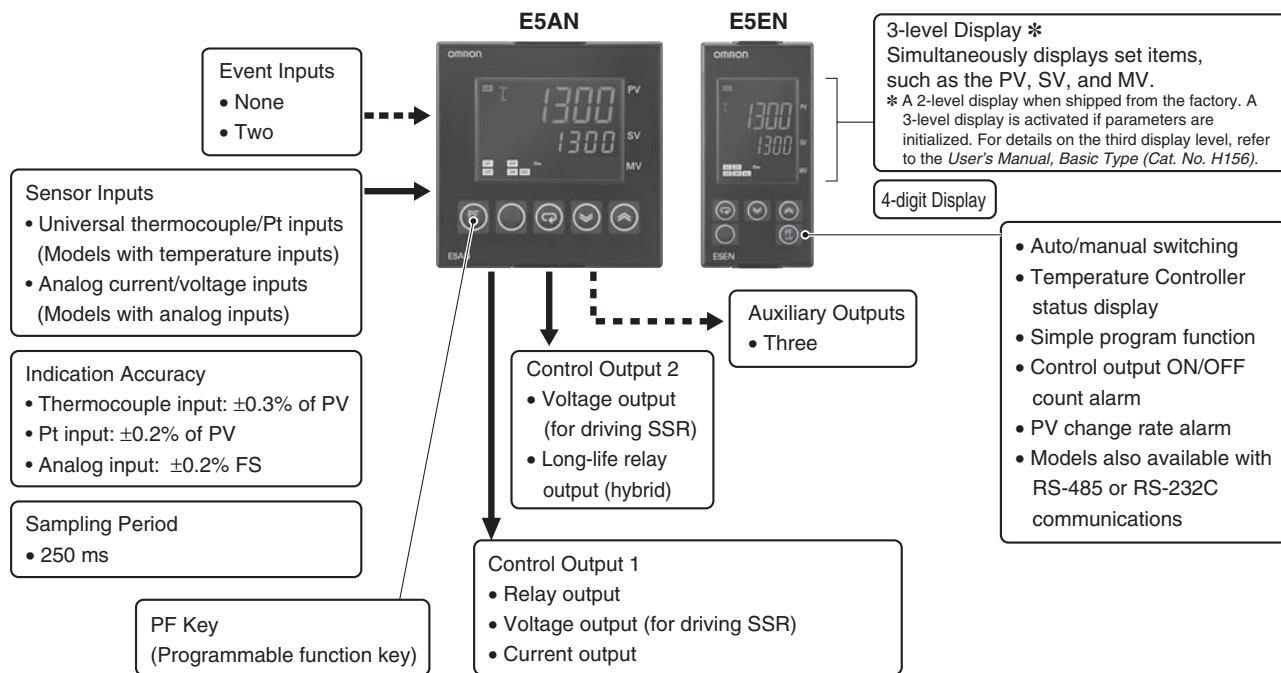

This data sheet is provided as a guideline for selecting products. Be sure to refer to the following user manuals for application precautions and other information required for operation before attempting to use the product.

E5CN/E5AN/E5EN Digital Temperature Controllers User's Manual Basic Type (Cat. No. H156)

E5CN/E5AN/E5EN Digital Temperature Controllers Communications Manual Basic Type (Cat. No. H158)

E5CN (96 x 96 mm)
E5CN-U (48 x 48 mm)

E5AN (96 x 96 mm)
E5EN (48 x 96 mm)

E5CN-H (48 x 48 mm)

E5AN-H (96 x 96 mm)
E5EN-H (48 x 96 mm)

Operation

Safety Precautions

E5AN/E5EN

Lineup

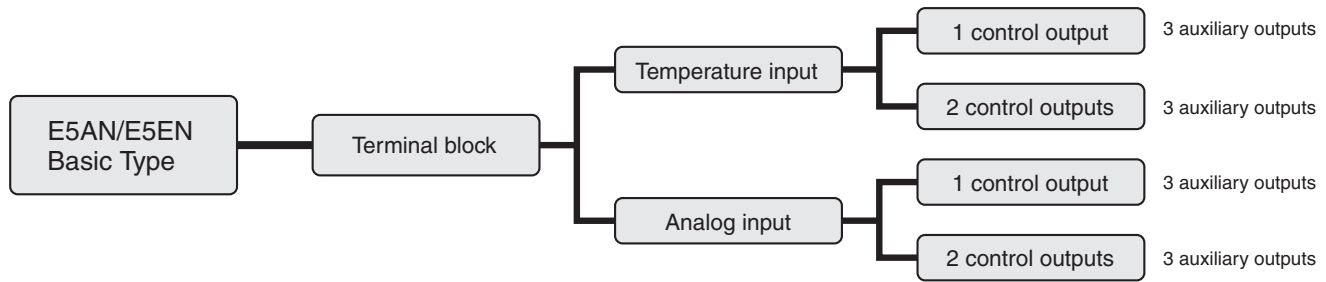

Note: Models with one control output or two control outputs can be used for heating/cooling control.

Model Number Structure

Model Number Legend

Controllers

E5AN/E5EN- 3 M - 500-N
 1 2 3 4 5 6 7 8 9

- 1. Control Output 1**
 R: Relay output
 Q: Voltage output (for driving SSR)
 C: Current output
- 2. Auxiliary Outputs**
 3: Three outputs
- 3. Heater Burnout/SSR Failure, Control Output 2, or External Power Supply for ES1B**
 Blank: None
 Q: Control output 2 (voltage output for driving SSR)
 Y: Long-life relay output (hybrid)
 H: Heater burnout/SSR failure/Heater overcurrent detection (CT1)
 HH: Heater burnout/SSR failure/Heater overcurrent detection (CT2)
 P: Power supply for sensor
- 4. Option**
 M: Option Unit can be mounted.
- 5. Input Type**
 T: Universal thermocouple/platinum resistance thermometer input
 L: Analog current/voltage input
- 6. Power Supply Voltage**
 Blank: 100 to 240 VAC
 D: 24 VAC/VDC
- 7. Case Color**
 Blank: Black
 W: Silver
- 8. Terminal Cover**
 -500: With terminal cover
- 9. Version**
 N: Available only to models released after January 2008.

Option Units

E53-
 1

- 1. Function**
 EN01: RS-232C communications
 EN03: RS-485 communications
 AKB: Event input

E5CN
E5CN-U (48 x 48 mm)

E5AN (96 x 96 mm)
E5EN (48 x 96 mm)

E5CN-H (48 x 48 mm)

E5AN-H (96 x 96 mm)
E5EN-H (48 x 96 mm)

Operation

Safety Precautions

Ordering Information

E5AN
Controllers with Terminal Blocks

Size	Case color	Power supply voltage	Input type	Auxiliary outputs	Control output 1	Functions			Model
						Heater burnout	Power supply for Sensor	Control output 2	
1/4 DIN 96 × 96 × 78 (W × H × D)	Black	100 to 240 VAC	Thermocouple or Resistance thermometer	3	Relay output				E5AN-R3MT-500-N
					Voltage output (for driving SSR)				E5AN-Q3MT-500-N
					Current output				E5AN-C3MT-500-N
					Relay output	1			E5AN-R3HMT-500-N
					Voltage output (for driving SSR)	1			E5AN-Q3HMT-500-N
					Relay output	2			E5AN-R3HHMT-500-N
					Voltage output (for driving SSR)	2			E5AN-Q3HHMT-500-N
					Relay output			Voltage output	E5AN-R3QMT-500-N
					Voltage output (for driving SSR)			Voltage output	E5AN-Q3QMT-500-N
					Current output			Voltage output	E5AN-C3QMT-500-N
					Relay output			Long-life relay output	E5AN-R3YMT-500-N
					Voltage output (for driving SSR)				E5AN-Q3YMT-500-N
		Current output			E5AN-C3YMT-500-N				
		Relay output		Sensor Power		E5AN-R3PMT-500-N			
		Voltage output (for driving SSR)		Sensor Power		E5AN-Q3PMT-500-N			
		Relay output				E5AN-R3ML-500-N			
		Voltage output (for driving SSR)				E5AN-Q3ML-500-N			
		Current output				E5AN-C3ML-500-N			
	Relay output	1			E5AN-R3HML-500-N				
	Voltage output (for driving SSR)	1			E5AN-Q3HML-500-N				
	Voltage output (for driving SSR)			Long-life relay output	E5AN-Q3YML-500-N				
	Relay output				E5AN-R3MTD-500-N				
	Voltage output (for driving SSR)				E5AN-Q3MTD-500-N				
	Current output				E5AN-C3MTD-500-N				
Relay output	1			E5AN-R3HMTD-500-N					
Voltage output (for driving SSR)	1			E5AN-Q3HMTD-500-N					
Relay output	2			E5AN-R3HHMTD-500-N					
Voltage output (for driving SSR)	2			E5AN-Q3HHMTD-500-N					
Relay output				E5AN-R3MT-W-500-N					
Voltage output (for driving SSR)				E5AN-Q3MT-W-500-N					
Current output				E5AN-C3MT-W-500-N					
Relay output	1			E5AN-R3HMT-W-500-N					
Voltage output (for driving SSR)	1			E5AN-Q3HMT-W-500-N					
Relay output				E5AN-R3MTD-W-500-N					
Voltage output (for driving SSR)				E5AN-Q3MTD-W-500-N					
Current output				E5AN-C3MTD-W-500-N					

E5CN
E5CN-U (48 x 48 mm)

E5AN (96 x 96 mm)
E5EN (48 x 96 mm)

E5CN-H (48 x 48 mm)

E5AN-H (96 x 96 mm)
E5EN-H (48 x 96 mm)

Operation

Safety Precautions

E5AN/E5EN

E5EN Controllers with Terminal Blocks

Size	Case color	Power supply voltage	Input type	Auxiliary outputs	Control output 1	Functions			Model	
						Heater burnout	Power supply for Sensor	Control output 2		
1/8 DIN 48 × 96 × 78 (W × H × D)	Black	100 to 240 VAC	Thermocouple or Resistance thermometer	3	Relay output				E5EN-R3MT-500-N	
					Voltage output (for driving SSR)				E5EN-Q3MT-500-N	
					Current output				E5EN-C3MT-500-N	
					Relay output	1			E5EN-R3HMT-500-N	
					Voltage output (for driving SSR)	1			E5EN-Q3HMT-500-N	
					Relay output	2			E5EN-R3HHMT-500-N	
					Voltage output (for driving SSR)	2			E5EN-Q3HHMT-500-N	
					Relay output			Voltage output	E5EN-R3QMT-500-N	
					Voltage output (for driving SSR)			Voltage output	E5EN-Q3QMT-500-N	
					Current output			Voltage output	E5EN-C3QMT-500-N	
					Relay output			Long-life relay output	E5EN-R3YMT-500-N	
					Voltage output (for driving SSR)			Long-life relay output	E5EN-Q3YMT-500-N	
	Current output			Long-life relay output	E5EN-C3YMT-500-N					
	Relay output		Sensor Power		E5EN-R3PMT-500-N					
	Voltage output (for driving SSR)		Sensor Power		E5EN-Q3PMT-500-N					
	Relay output				E5EN-R3ML-500-N					
	Voltage output (for driving SSR)				E5EN-Q3ML-500-N					
	Current output				E5EN-C3ML-500-N					
	Relay output	1			E5EN-R3HML-500-N					
	Voltage output (for driving SSR)	1			E5EN-Q3HML-500-N					
				Long-life relay output	E5EN-Q3YML-500-N					
	Silver	100 to 240 VAC	Thermocouple or Resistance thermometer	3	Relay output				E5EN-R3MTD-500-N	
					Voltage output (for driving SSR)				E5EN-Q3MTD-500-N	
					Current output				E5EN-C3MTD-500-N	
Relay output					1			E5EN-R3HMTD-500-N		
Voltage output (for driving SSR)					1			E5EN-Q3HMTD-500-N		
Relay output					2			E5EN-R3HHMTD-500-N		
Voltage output (for driving SSR)		2					E5EN-Q3HHMTD-500-N			
24 VAC/VDC					Relay output					E5EN-R3MT-W-500-N
					Voltage output (for driving SSR)					E5EN-Q3MT-W-500-N
					Current output					E5EN-C3MT-W-500-N
					Relay output	1				E5EN-R3HMT-W-500-N
					Voltage output (for driving SSR)	1				E5EN-Q3HMT-W-500-N
	Relay output						E5EN-R3MTD-W-500-N			
Voltage output (for driving SSR)					E5EN-Q3MTD-W-500-N					
Current output					E5EN-C3MTD-W-500-N					

E5CN
E5CN-U (48 x 48 mm)

E5AN (96 x 96 mm)
E5EN (48 x 96 mm)

E5CN-H (48 x 48 mm)

E5AN-H (96 x 96 mm)
E5EN-H (48 x 96 mm)

Operation

Safety Precautions

Option Units

Name	Function	Model
Communications Unit	RS-232C communications	E53-EN01
	RS-485 communications	E53-EN03
Event Input Unit	Event inputs	E53-AKB

Accessories (Order Separately)

USB-Serial Conversion Cable

Model
E58-CIFQ1

Terminal Cover

Connectable models	Model
E5AN	E53-COV16
E5EN	

Note: The Terminal Cover comes with the E5CN-□□□-500 models.

Waterproof Packing

Connectable models	Model
E5AN	Y92S-P4
E5EN	Y92S-P5

Note: The Waterproof Packing is included with the Controller.

Current Transformers (CTs)

Hole diameter	Model
5.8 dia.	E54-CT1
12.0 dia.	E54-CT3

CX-Thermo Support Software

Model
EST2-2C-MV4

E5CN
E5CN-U (48 x 48 mm)

E5AN (96 x 96 mm)
E5EN (48 x 96 mm)

E5CN-H (48 x 48 mm)

E5AN-H (96 x 96 mm)
E5EN-H (48 x 96 mm)

Operation

Safety Precautions

E5AN/E5EN

Specifications

Ratings

Power supply voltage		No D in model number: 100 to 240 VAC, 50/60 Hz D in model number: 24 VAC, 50/60 Hz; 24 VDC
Operating voltage range		85% to 110% of rated supply voltage
Power consumption		100 to 240 VAC: 10 VA 24 VAC/VDC: 5.5 VA (24 VAC)/4 W (24 VDC)
Sensor input		Models with temperature inputs Thermocouple: K, J, T, E, L, U, N, R, S, B, W, or PL II Platinum resistance thermometer: Pt100 or JPt100 Infrared temperature sensor: 10 to 70°C, 60 to 120°C, 115 to 165°C, or 140 to 260°C Voltage input: 0 to 50 mV
		Models with analog inputs Current input: 4 to 20 mA or 0 to 20 mA Voltage input: 1 to 5 V, 0 to 5 V, or 0 to 10 V
Input impedance		Current input: 150 Ω max., Voltage input: 1 MΩ min. (Use a 1:1 connection when connecting the ES2-HB.)
Control method		ON/OFF control or 2-PID control (with auto-tuning)
Control output	Relay output	SPST-NO, 250 VAC, 5 A (resistive load), electrical life: 100,000 operations, minimum applicable load: 5 V, 10 mA
	Voltage output (for driving SSR)	Output voltage: 12 VDC ±15% (PNP), max. load current: 40 mA, With short-circuit protection circuit: Max. load current of 21 mA for control output 2
	Current output	4 to 20 mA DC/0 to 20 mA DC, load: 600 Ω max., resolution: approx. 10,000
	Long-life relay output	SPST-NO, 250 VAC, 3 A (resistive load), electrical life: 1,000,000 operations, load power supply voltage: 75 to 250 VAC (DC loads cannot be connected.), minimum applicable load: 5 V, 10 mA, leakage current: 5 mA max. (250 VAC, 60 Hz)
Auxiliary output	Number of outputs	3
	Output specifications	Relay output: SPST-NO, 250 VAC, 3 A (resistive load), electrical life: 100,000 operations, minimum applicable load: 5 V, 10 mA
Event input	Number of inputs	2
	External contact input specifications	Contact input: ON: 1 kΩ max., OFF: 100 kΩ min. Non-contact input: ON: Residual voltage: 1.5 V max., OFF: Leakage current: 0.1 mA max. Current flow: Approx. 7 mA per contact
External power supply for ES1B		12 VDC ±10%, 20 mA, short-circuit protection circuit provided
Setting method		Digital setting using front panel keys
Indication method		11-segment digital display and individual indicators (7-segments displays also possible) Character height: E5AN: PV: 15.8 mm, SV: 9.5 mm, MV: 6.8 mm; E5EN: PV: 11.8 mm, SV: 8.1 mm, MV: 5.8 mm Content of 3-level display: PV/SV/MV, PV/SV/multi-SP, or soak time remain * Number of digits: 4 for PV, SV, and MV
Multi SP		Up to four set points (SP0 to SP3) can be saved and selected using event inputs, key operations, or serial communications.
Bank switching		Not supported.
Other functions		Manual output, heating/cooling control, loop burnout alarm, SP ramp, other alarm functions, heater burnout detection, 40% AT, 100% AT, MV limiter, input digital filter, self-tuning, temperature input shift, run/stop, protection functions, control output ON/OFF counter, extraction of square root, MV change rate limit, logic operations, PV/SV status display, simple program, automatic cooling coefficient adjustment
Ambient operating temperature		-10 to 55°C (with no condensation or icing), for 3-year warranty: -10 to 50°C
Ambient operating humidity		25% to 85%
Storage temperature		-25 to 65°C (with no condensation or icing)

* A 2-level display when shipped from the factory. A 3-level display is activated if parameters are initialized. For details on the third display level, refer to the *User's Manual, Basic Type* (Cat. No. H156).

E5CN
E5CN-U
(48 x 48 mm)

E5AN
E5EN
(96 x 96 mm)
(48 x 96 mm)

E5CN-H
(48 x 48 mm)

E5AN-H
E5EN-H
(96 x 96 mm)
(48 x 96 mm)

Operation

Safety Precautions

Alarm Outputs

Each alarm can be independently set to one of the following 13 alarm types. The default is 2: *Upper limit*. Auxiliary outputs are allocated for alarms. ON delays and OFF delays (0 to 999 s) can also be specified.

Note: For models with heater burnout, SSR failure, and heater overcurrent detection, alarm 1 will be an OR output of the alarm selected from the following alarm types and the alarms for heater burnout, SSR failure, and heater overcurrent. To output only a heater burnout alarm, SSR failure alarm, and heater overcurrent alarm for alarm 1, set the alarm type to 0 (i.e., no alarm function).

Set value	Alarm type	Alarm output operation	
		When X is positive	When X is negative
0	Alarm function OFF	Output OFF	
1 *1	Upper- and lower-limit		*2
2	Upper limit		
3	Lower limit		
4 *1	Upper- and lower-limit range		*3
5 *1	Upper- and lower-limit with standby sequence		*4
6	Upper-limit with standby sequence		
7	Lower-limit with standby sequence		
8	Absolute-value upper-limit		
9	Absolute-value lower-limit		
10	Absolute-value upper-limit with standby sequence		
11	Absolute-value lower-limit with standby sequence		
12	LBA (for alarm 1 only)	---	---
13	PV change rate alarm	---	---

*1. With set values 1, 4 and 5, the upper and lower limit values can be set independently for each alarm type, and are expressed as "L" and "H."

*2. Set value: 1, Upper- and lower-limit alarm

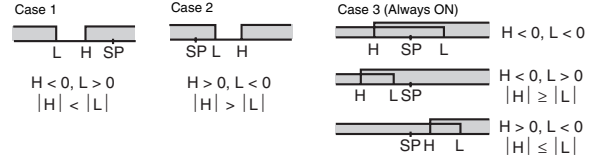

*3. Set value: 4, Upper- and lower-limit range

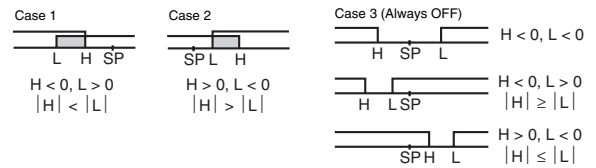

*4. Set value: 5, Upper- and lower-limit with standby sequence
For Upper- and Lower-Limit Alarm Described Above

- Case 1 and 2
Always OFF when the upper-limit and lower-limit hysteresis overlaps.
- Case 3: Always OFF

*5. Set value: 5, Upper- and lower-limit with standby sequence
Always OFF when the upper-limit and lower-limit hysteresis overlaps.

E5CN (96 x 96 mm)
E5CN-U (48 x 48 mm)

E5AN (96 x 96 mm)
E5EN (48 x 96 mm)

E5CN-H (48 x 48 mm)

E5AN-H (96 x 96 mm)
E5EN-H (48 x 96 mm)

Operation

Safety Precautions

Characteristics

Indication accuracy	Thermocouple: ($\pm 0.3\%$ of indicated value or $\pm 1^\circ\text{C}$, whichever is greater) ± 1 digit max. *1 Platinum resistance thermometer: ($\pm 0.2\%$ of indicated value or $\pm 0.8^\circ\text{C}$, whichever is greater) ± 1 digit max. Analog input: $\pm 0.2\%$ FS ± 1 digit max. CT input: $\pm 5\%$ FS ± 1 digit max.	
Transfer output accuracy	$\pm 0.3\%$ FS max.	
Influence of temperature *2	Thermocouple input (R, S, B, W, PL II): ($\pm 1\%$ of PV or $\pm 10^\circ\text{C}$, whichever is greater) ± 1 digit max. Other thermocouple input: ($\pm 1\%$ of PV or $\pm 4^\circ\text{C}$, whichever is greater) ± 1 digit max. *3	
Influence of voltage *2	Platinum resistance thermometer: ($\pm 1\%$ of PV or $\pm 2^\circ\text{C}$, whichever is greater) ± 1 digit max. Analog input: ($\pm 1\%$ FS) ± 1 digit max.	
Input sampling period	250 ms	
Hysteresis	Models with thermocouple/platinum resistance thermometer input (universal input): 0.1 to 999.9 EU (in units of 0.1 EU) *4 Models with analog input: 0.01 to 99.99% FS (in units of 0.01% FS)	
Proportional band (P)	Models with thermocouple/platinum resistance thermometer input (universal input): 0.1 to 999.9 EU (in units of 0.1 EU) *4 Models with analog input: 0.1 to 999.9% FS (in units of 0.1% FS)	
Integral time (I)	0 to 3999 s (in units of 1 s)	
Derivative time (D)	0 to 3999 s (in units of 1 s) *5	
Control period	0.5, 1 to 99 s (in units of 1 s)	
Manual reset value	0.0 to 100.0% (in units of 0.1%)	
Alarm setting range	-1999 to 9999 (decimal point position depends on input type)	
Affect of signal source resistance	Thermocouple: $0.1^\circ\text{C}/\Omega$ max. (100 Ω max.) Platinum resistance thermometer: $0.1^\circ\text{C}/\Omega$ max. (10 Ω max.)	
Insulation resistance	20 M Ω min. (at 500 VDC)	
Dielectric strength	2,300 VAC, 50 or 60 Hz for 1 min (between terminals with different charge)	
Vibration resistance	Malfunction	10 to 55 Hz, 20 m/s ² for 10 min each in X, Y, and Z directions
	Destruction	10 to 55 Hz, 0.75-mm single amplitude for 2 hrs each in X, Y, and Z directions
Shock resistance	Malfunction	100 m/s ² , 3 times each in X, Y, and Z directions
	Destruction	300 m/s ² , 3 times each in X, Y, and Z directions
Weight	E5AN	Controller: Approx. 310 g, Mounting Bracket: Approx. 100 g
	E5EN	Controller: Approx. 260 g, Mounting Bracket: Approx. 100 g
Degree of protection	Front panel: IP66, Rear case: IP20, Terminals: IP00	
Memory protection	Non-volatile memory (number of writes: 1,000,000 times)	
Setup Tool	CX-Thermo version 4.0 or higher	
Setup Tool port	Provided on the bottom of the E5AN and E5EN. An E58-CIFQ1 USB-Serial Conversion Cable is required to connect the computer to the E5AN and E5EN *6	
Standards	Approved standards	UL 61010-1, CSA C22.2 No. 1010-1
	Conformed standards	EN 61010-1 (IEC 61010-1): Pollution level 2, overcurrent category II
EMC	EMI: Radiated Interference Electromagnetic Field Strength: EN 55011 Group 1, class A Noise Terminal Voltage: EN 55011 Group 1, class A EMS: ESD Immunity: EN 61000-4-2 Electromagnetic Field Immunity: EN 61000-4-3 Burst Noise Immunity: EN 61000-4-4 Conducted Disturbance Immunity: EN 61000-4-6 Surge Immunity: EN 61000-4-5 Power Frequency Magnetic Field Immunity: EN 61000-4-8 Voltage Dip/Interrupting Immunity: EN 61000-4-11	

*1. The indication accuracy of K thermocouples in the -200 to 1300°C range, T and N thermocouples at a temperature of -100°C max., and U and L thermocouples at any temperatures is $\pm 2^\circ\text{C} \pm 1$ digit max. The indication accuracy of the B thermocouple at a temperature of 400°C max. is not specified. The indication accuracy of B thermocouples in the 400 to 800°C range is $\pm 3^\circ\text{C}$ max. The indication accuracy of the R and S thermocouples at a temperature of 200°C max. is $\pm 3^\circ\text{C} \pm 1$ digit max. The indication accuracy of W thermocouples is ± 0.3 of PV or $\pm 3^\circ\text{C}$, whichever is greater, ± 1 digit max. The indication accuracy of PL II thermocouples is ± 0.3 of PV or $\pm 2^\circ\text{C}$, whichever is greater, ± 1 digit max.

*2. Ambient temperature: -10°C to 23°C to 55°C , Voltage range: -15% to 10% of rated voltage

*3. K thermocouple at -100°C max.: $\pm 10^\circ\text{C}$ max.

*4. "EU" stands for Engineering Unit and is used as the unit after scaling. For a temperature sensor, the EU is $^\circ\text{C}$ or $^\circ\text{F}$.

*5. When robust tuning (RT) is ON, the differential time is 0.0 to 999.9 (in units of 0.1 s).

*6. External communications (RS-232C or RS-485) and cable communications for the Setup Tool can be used at the same time.

E5CN
E5CN-U (48 x 48 mm)E5AN (96 x 96 mm)
E5EN (48 x 96 mm)

E5CN-H (48 x 48 mm)

E5AN-H (96 x 96 mm)
E5EN-H (48 x 96 mm)

Operation

Safety Precautions

E5AN/E5EN

E5CN
E5CN-U (48 x 48 mm)

USB-Serial Conversion Cable

Applicable OS	Windows 2000, XP, or Vista
Applicable software	Thermo Mini, CX-Thermo version 4.0 or higher
Applicable models	E5AN/E5EN/E5CN/E5CN-U/E5AN-H/E5EN-H/E5CN-H
USB interface standard	Conforms to USB Specification 1.1.
DTE speed	38400 bps
Connector specifications	Computer: USB (type A plug) Temperature Controller: Setup Tool port (on bottom of Controller)
Power supply	Bus power (Supplied from USB host controller.)
Power supply voltage	5 VDC
Current consumption	70 mA
Ambient operating temperature	0 to 55°C (with no condensation or icing)
Ambient operating humidity	10% to 80%
Storage temperature	-20 to 60°C (with no condensation or icing)
Storage humidity	10% to 80%
Altitude	2,000 m max.
Weight	Approx. 100 g

Note: A driver must be installed in the personal computer. Refer to installation information in the operation manual for the Conversion Cable.

E5AN (96 x 96 mm)
E5EN (48 x 96 mm)

Communications Specifications

Transmission line connection method	RS-485: Multipoint RS-232C: Point-to-point
Communications	RS-485 (two-wire, half duplex) or RS-232C
Synchronization method	Start-stop synchronization
Protocol	CompoWay/F, SYSWAY, or Modbus
Baud rate	1200, 2400, 4800, 9600, 19200, 38400, or 57600 bps
Transmission code	ASCII
Data bit length *	7 or 8 bits
Stop bit length *	1 or 2 bits
Error detection	Vertical parity (none, even, odd) Frame check sequence (FCS) with SYSWAY Block check character (BCC) with CompoWay/F or CRC-16 Modbus
Flow control	None
Interface	RS-485, RS-232C
Retry function	None
Communications buffer	217 bytes
Communications response wait time	0 to 99 ms Default: 20 ms

* The baud rate, data bit length, stop bit length, and vertical parity can be individually set using the Communications Setting Level.

E5CN-H (48 x 48 mm)

E5AN-H (96 x 96 mm)
E5EN-H (48 x 96 mm)

Operation

Safety Precautions

Current Transformer (Order Separately) Ratings

Dielectric strength	1,000 VAC for 1 min
Vibration resistance	50 Hz, 98 m/s ²
Weight	E54-CT1: Approx. 11.5 g, E54-CT3: Approx. 50 g
Accessories (E54-CT3 only)	Armatures (2) Plugs (2)

Heater Burnout Alarms, SSR Failure Alarms, and Heater Overcurrent Alarms

CT input (for heater current detection)	Models with detection for single-phase heaters: One input Models with detection for single-phase or three-phase heaters: Two inputs
Maximum heater current	50 A AC
Input current indication accuracy	±5% FS ±1 digit max.
Heater burnout alarm setting range *1	0.1 to 49.9 A (in units of 0.1 A) Minimum detection ON time: 100 ms
SSR failure alarm setting range *2	0.1 to 49.9 A (in units of 0.1 A) Minimum detection OFF time: 100 ms
Heater overcurrent alarm setting range *3	0.1 to 49.9 A (in units of 0.1 A) Minimum detection ON time: 100 ms

- *1. For heater burnout alarms, the heater current will be measured when the control output is ON, and the output assigned to the alarm 1 function will turn ON if the heater current is lower than the set value (i.e., heater burnout detection current value).
- *2. For SSR failure alarms, the heater current will be measured when the control output is OFF, and the output assigned to the alarm 1 function will turn ON if the heater current is higher than the set value (i.e., SSR failure detection current value).
- *3. For heater overcurrent alarms, the heater current will be measured when the control output is ON, and the output assigned to the alarm 1 function will turn ON if the heater current is higher than the set value (i.e., heater overcurrent detection current value).

Electrical Life Expectancy Curve for Relays (Reference Values)

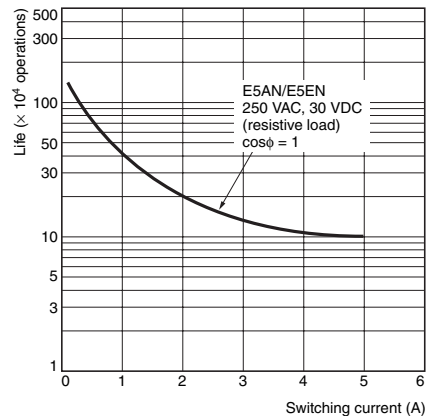

Note: Do not connect a DC load to a Controller with a Long-life Relay Output.

External Connections

- A voltage output (control output 1, for driving SSR) is not electrically insulated from the internal circuits. When using a grounding thermocouple, do not connect any of the control output terminals to ground. If the control output terminals are connected to ground, errors will occur in the measured temperature values as a result of leakage current.
The voltage output (control output 2, for driving SSR) has basic insulation provided for the internal circuit.
- Consult with your OMRON representative before using the external power supply for the ES1B for any other purpose.

Controllers

- 100 to 240 VAC
- 24 VAC/VDC (no polarity)

Control output 1

Relay output
250 VAC, 5A
(resistive load)
Voltage output
(for driving SSR)
12 VDC, 40 mA
Current output
0 to 20 mA DC
4 to 20 mA DC
Load: 600 Ω max.

Control output 2

Voltage output
(for driving SSR)
12 VDC, 21 mA
Long-life relay output
250 VAC, 3 A
(resistive load)

**Auxiliary output
1, 2, 3**

Relay outputs
250 VAC, 3 A
(resistive load)

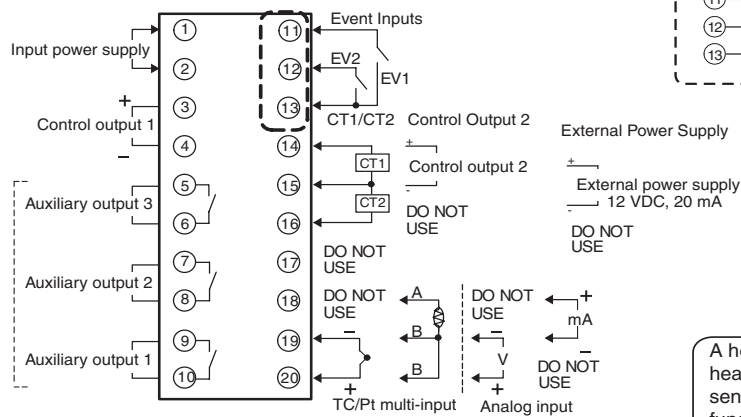

Option Units

Communications		
E53-EN01 RS-232C	E53-EN03 RS-485	E53-AKB Event inputs
①—SD	①—B (+)	①—EV2
②—RD	②—A (-)	②—EV
③—SG	③—DO NOT USE	③—CT1/CT2

A heater burnout alarm, heater short alarm, heater overcurrent alarm, or input alarm is sent to the output to which the alarm 1 function is assigned.

E5CN
E5CN-U (48 x 48 mm)

E5AN (96 x 96 mm)
E5EN (48 x 96 mm)

E5CN-H (48 x 48 mm)

E5AN-H (96 x 96 mm)
E5EN-H (48 x 96 mm)

Operation

Safety Precautions

E5AN/E5EN

Nomenclature

E5CN
E5CN-U (48 x 48 mm)

E5AN (96 x 96 mm)
E5EN (48 x 96 mm)

E5AN

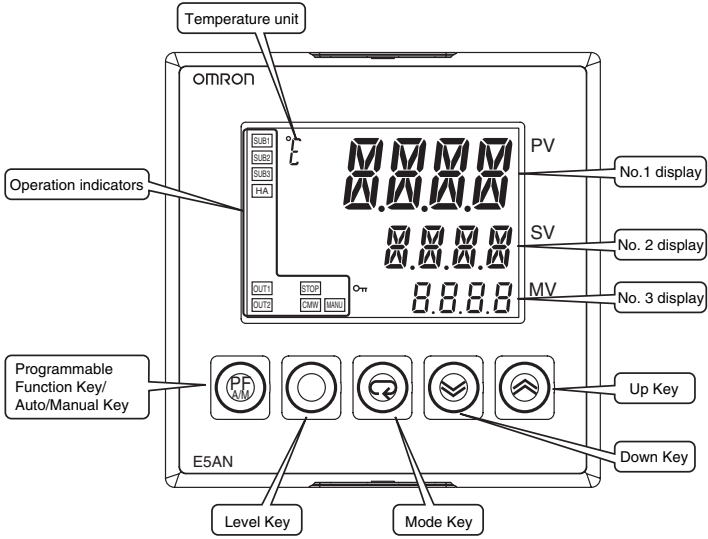

E5EN

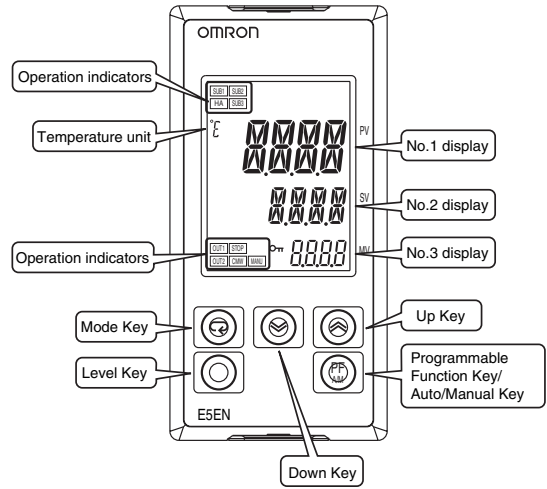

* A 2-level display when shipped from the factory. A 3-level display is activated if parameters are initialized. For details on the third display level, refer to the *User's Manual, Basic Type* (Cat. No. H156).

E5CN-H (48 x 48 mm)

E5AN-H (96 x 96 mm)
E5EN-H (48 x 96 mm)

Dimensions

(Unit: mm)

E5AN

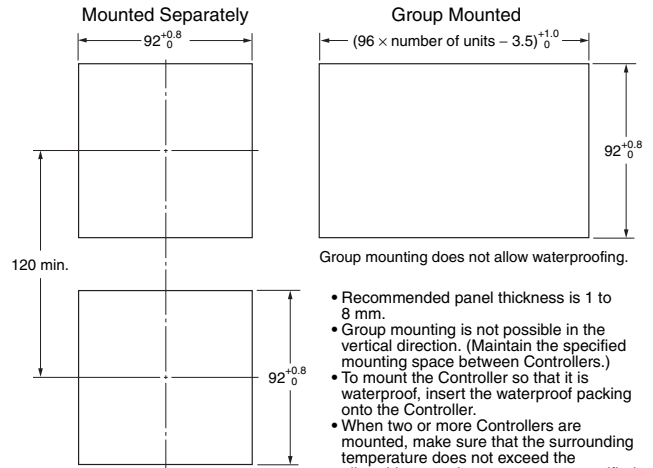
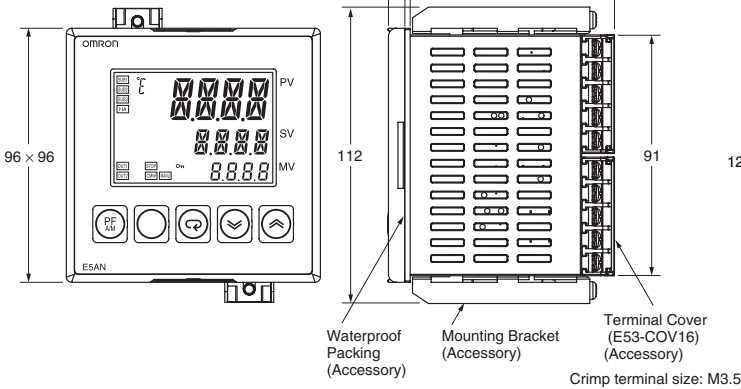

- Recommended panel thickness is 1 to 8 mm.
- Group mounting is not possible in the vertical direction. (Maintain the specified mounting space between Controllers.)
- To mount the Controller so that it is waterproof, insert the waterproof packing onto the Controller.
- When two or more Controllers are mounted, make sure that the surrounding temperature does not exceed the allowable operating temperature specified in the specifications.

Operation

Safety Precautions

E5EN

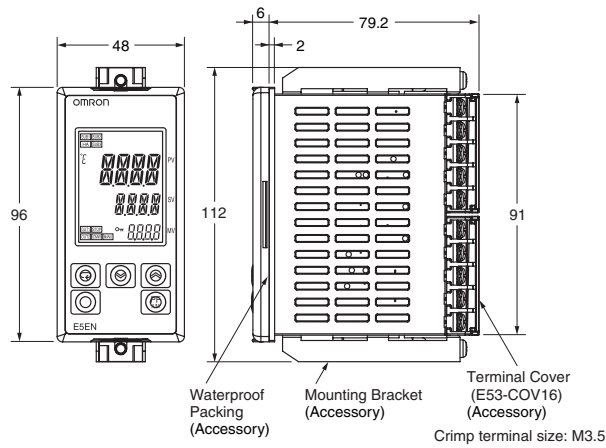

Mounted Separately

Group Mounted

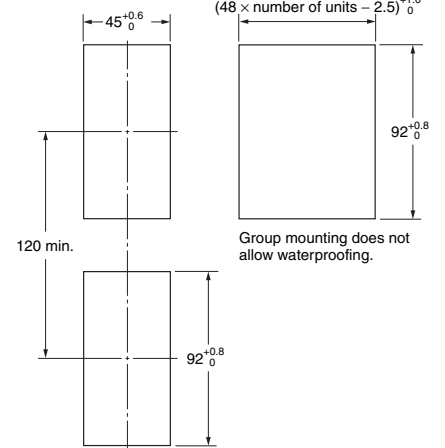

- Recommended panel thickness is 1 to 8 mm.
- Group mounting is not possible in the vertical direction. (Maintain the specified mounting space between Controllers.)
- To mount the Controller so that it is waterproof, insert the waterproof packing onto the Controller.
- When two or more Controllers are mounted, make sure that the surrounding temperature does not exceed the allowable operating temperature specified in the specifications.

Accessories (Order Separately)

USB-Serial Conversion Cable E58-CIFQ1

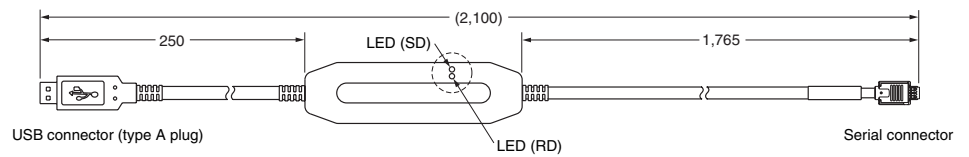
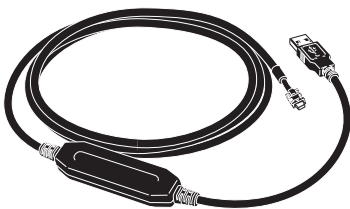

Terminal Covers E53-COV16 (Six Covers provided.)

E53-COV16 (Six Covers provided.)

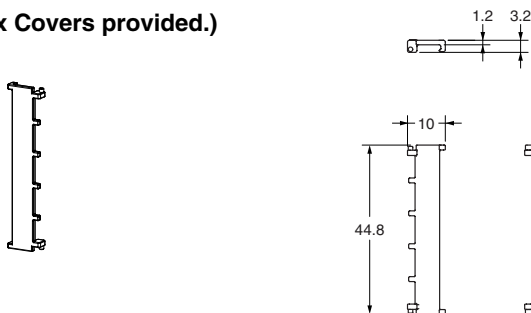

E5CN
E5CN-U (48 x 48 mm)

E5AN (96 x 96 mm)
E5EN (48 x 96 mm)

E5CN-H (48 x 48 mm)

E5AN-H (96 x 96 mm)
E5EN-H (48 x 96 mm)

Operation

Safety Precautions

E5AN/E5EN

Waterproof Packing

Y92S-P4 (for DIN 96 × 96)

Y92S-P5 (for DIN 48 × 96)

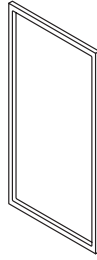
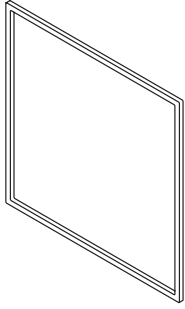

Order the Waterproof Packing separately if it becomes lost or damaged.

The Waterproof Packing can be used to achieve an IP66 degree of protection.

(Deterioration, shrinking, or hardening of the waterproof packing may occur depending on the operating environment. Therefore, periodic replacement is recommended to ensure the level of waterproofing specified in IP66. The time for periodic replacement depends on the operating environment. Be sure to confirm this point at your site. Consider one year a rough standard. OMRON shall not be liable for the level of water resistance if the customer does not perform periodic replacement.)

The Waterproof Packing does not need to be attached if a waterproof structure is not required.

Current Transformers

E54-CT1

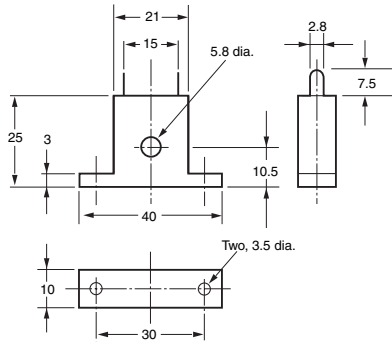
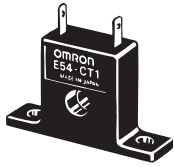

E54-CT1

Thru-current (Io) vs. Output Voltage (Eo) (Reference Values)

Maximum continuous heater current: 50 A (50/60 Hz)
Number of windings: 400±2
Winding resistance: 18±2 Ω

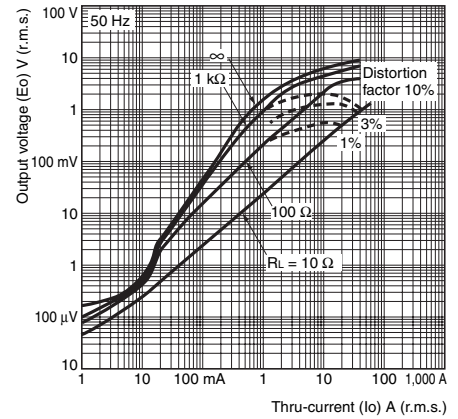

E54-CT3

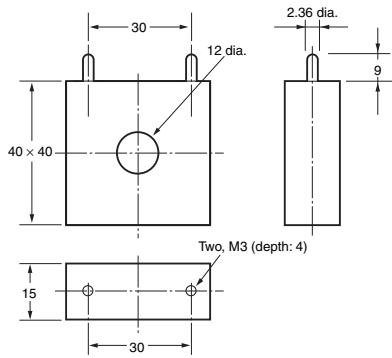

E54-CT3

Thru-current (Io) vs. Output Voltage (Eo) (Reference Values)

Maximum continuous heater current: 120 A (50/60 Hz)
(Maximum continuous heater current for an OMRON Temperature Controller is 50 A.)
Number of windings: 400±2
Winding resistance: 8±0.8 Ω

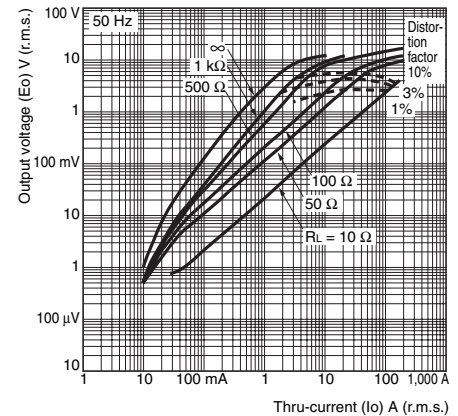

E54-CT3 Accessory

- Armature

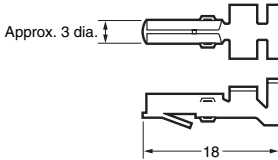

- Plug

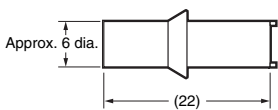

Connection Example

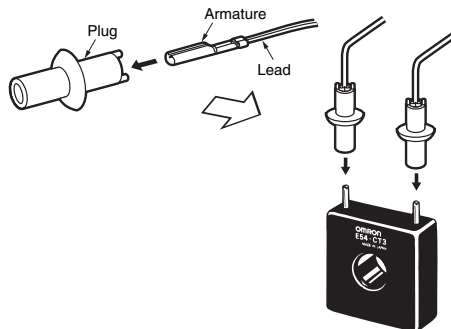

E5CN-H (48 x 48 mm)

E5AN-H (96 x 96 mm)
E5EN-H (48 x 96 mm)

Operation

Safety Precautions

Advanced Digital Temperature Controller E5CN-H (48 x 48 mm)

**A New High-performance Controller: High Resolution, High Speed, and High Input Accuracy.
Logic Operations and Preventive Maintenance Function.**

- High-resolution display with 5 digits/0.01°C display in a compact Controller (48 x 48 mm).
- High-speed sampling cycle of 60 ms.
- High Accuracy
Thermocouple/Pt input: $\pm 0.1\%$ of PV
Analog input: $\pm 0.1\%$ FS
- Universal inputs on all models (thermocouple, PT, or analog input) to handle various sensors with one Controller.
- A PV/SV-status display function can be set to automatically alternate between displaying the status of the Temperature Controller (auto/manual, RUN/STOP, and alarms) and the PV or SV.
- Flexible contact outputs with logic operations (AND, OR, and delays) set from the Support Software (CX-Thermo Ver. 4.0)
- Preventive maintenance for relays in the Temperature Controller using a Control Output ON/OFF Counter.



48 × 48 mm
E5CN-H



NEW

⚠ Refer to *Safety Precautions* on page 66.

Main I/O Functions

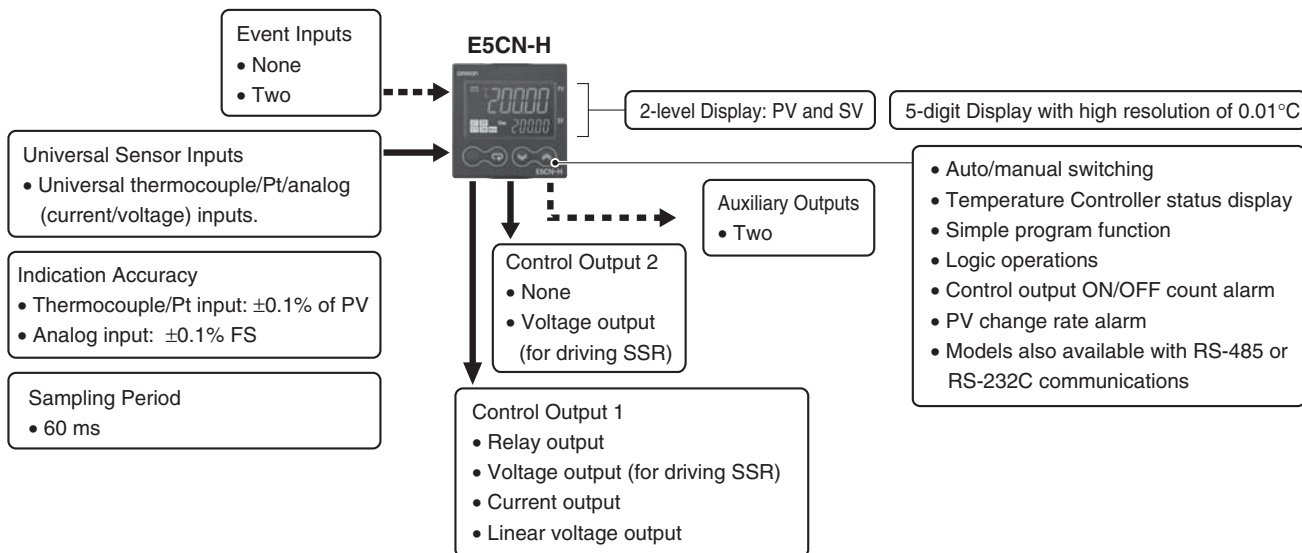

This data sheet is provided as a guideline for selecting products. Be sure to refer to the following user manuals for application precautions and other information required for operation before attempting to use the product.

E5CN-H/E5AN-H/E5EN-H Digital Controllers User's Manual Advanced Type (Cat. No. H157)

E5CN-H/E5AN-H/E5EN-H Digital Controllers Communications Manual Advanced Type (Cat. No. H159)

E5CN
E5CN-U (48 x 48 mm)

E5AN (96 x 96 mm)
E5EN (48 x 96 mm)

E5CN-H (48 x 48 mm)

E5AN-H (96 x 96 mm)
E5EN-H (48 x 96 mm)

Operation

Safety Precautions

E5CN-H

Lineup

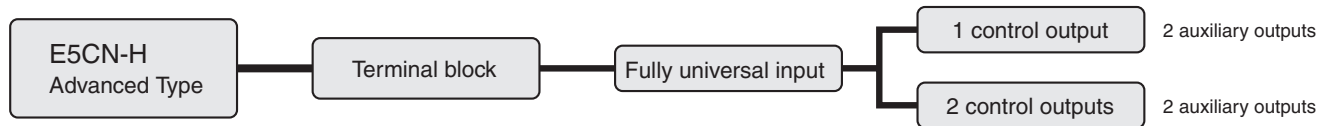

Note: Models with one control output and models with two control outputs can be used for heating/cooling control.

Model Number Structure

Model Number Legend

Controllers

E5CN-M--500

1 2 3 4 5 6 7

1. **Type**
H: Advanced
2. **Control Output 1**
R: Relay output
Q: Voltage output (for driving SSR)
C: Current output
V: Linear voltage output
3. **Auxiliary Outputs**
2: Two outputs
4. **Option 1**
M: Option Unit can be mounted.
5. **Power Supply Voltage**
Blank: 100 to 240 VAC
D: 24 VAC/VDC
6. **Case Color**
Blank: Black
W: Silver
7. **Terminal Cover**
-500: With terminal cover

Option Units

E53-

1 2 3 4

1. **Applicable Controller**
CN: E5CN-H or E5CN
2. **Function 1**
Blank: None
Q: Control output 2 (voltage output for driving SSR)
P: Power supply for sensor
C: Current output
3. **Function 2**
Blank: None
H: Heater burnout/SSR failure/Heater overcurrent detection (CT1)
HH: Heater burnout/SSR failure/Heater overcurrent detection (CT2)
B: Two event inputs
03: RS-485 communications
H03: Heater burnout/SSR failure/Heater overcurrent detection (CT1) + RS-485 communications
HB: Heater burnout/SSR failure/Heater overcurrent detection (CT1) + Two event inputs
HH03: Heater burnout/SSR failure/Heater overcurrent detection (CT2) + RS-485 communications
H01: Heater burnout/SSR failure/Heater overcurrent detection (CT1)/RS-232C communications
F: Transfer output
BF: Two event inputs/Transfer output
4. **Version**
N2: Available only to models released after January 2008

Note: Not all combinations of function 1 and function 2 specifications are possible for Option Units (E53-).

E5CN
E5CN-U
(48 x 48 mm)

E5AN
E5EN
(96 x 96 mm)
(48 x 96 mm)

E5CN-H
(48 x 48 mm)

E5AN-H
E5EN-H
(96 x 96 mm)
(48 x 96 mm)

Operation

Safety Precautions

Ordering Information

Controllers

Size	Case Color	Power supply voltage	Auxiliary output	Control output 1	Model
1/16 DIN 48 × 48 × 78 (W × H × D)	Black	100 to 240 VAC	2	Relay output	E5CN-HR2M-500
				Voltage output (for driving SSR)	E5CN-HQ2M-500
				Current output	E5CN-HC2M-500
				Linear voltage output	E5CN-HV2M-500
		24 VAC/VDC	2	Relay output	E5CN-HR2MD-500
				Voltage output (for driving SSR)	E5CN-HQ2MD-500
	Current output			E5CN-HC2MD-500	
	Linear voltage output			E5CN-HV2MD-500	
	Silver	100 to 240 VAC	2	Relay output	E5CN-HR2M-W-500
				Voltage output (for driving SSR)	E5CN-HQ2M-W-500
				Current output	E5CN-HC2M-W-500
		24 VAC/VDC	2	Relay output	E5CN-HR2MD-W-500
Voltage output (for driving SSR)				E5CN-HQ2MD-W-500	
Current output				E5CN-HC2MD-W-500	

Option Units

One of the following Option Units can be mounted to provide the E5CN with additional functions.

Functions					Model
Communications RS-485		3-phase heater burnout/SSR failure/ Heater overcurrent detection			E53-CNH03N2
		Heater burnout/SSR failure/ Heater overcurrent detection	Event inputs		E53-CNHBN2
Communications RS-485				Control output 2 (Voltage for driving SSR)	E53-CNQ03N2
Communications RS-485		Heater burnout/SSR failure/ Heater overcurrent detection			E53-CNH03N2
Communications RS-485					E53-CN03N2
			Event inputs		E53-CNBN2
		Heater burnout/SSR failure/ Heater overcurrent detection		Control output 2 (Voltage for driving SSR)	E53-CNQH2N2
		3-phase heater burnout/SSR failure/ Heater overcurrent detection		Control output 2 (Voltage for driving SSR)	E53-CNQH2N2
			Event inputs	Control output 2 (Voltage for driving SSR)	E53-CNQB2N2
				Control output 2 (Voltage for driving SSR)	Transfer Output
			Event inputs	Transfer Output	E53-CNBF2N2
	Communications RS-232C			Control output 2 (Voltage for driving SSR)	E53-CNQ01N2
	Communications RS-232C				E53-CN01N2
	Communications RS-232C	Heater burnout/SSR failure/ Heater overcurrent detection			E53-CNH01N2

Note: These Option Units are applicable only to models released after January 2008.

Accessories (Order Separately)

USB-Serial Conversion Cable

Model
E58-CIFQ1

Terminal Cover

Model
E53-COV17

Note: 1. The Terminal Cover comes with the E5CN-□□□□-500 models.
2. The E53-COV10 cannot be used.

Waterproof Packing

Model
Y92S-29

Note: Waterproof Packing is included with the controller only for models with terminal blocks.

Current Transformers (CTs)

Hole diameter	Model
5.8 dia.	E54-CT1
12.0 dia.	E54-CT3

Adapter

Connectable models	Model
Terminal type	Y92F-45

Note: Use this Adapter when the panel has been previously prepared for the E5B□.

CX-Thermo Support Software

Model
EST2-2C-MV4

E5CN
E5CN-U (48 x 48 mm)

E5AN (96 x 96 mm)
E5EN (48 x 96 mm)

E5CN-H (48 x 48 mm)

E5AN-H (96 x 96 mm)
E5EN-H (48 x 96 mm)

Operation

Safety Precautions

E5CN-H

Specifications

Ratings

Power supply voltage		No D in model number: 100 to 240 VAC, 50/60 Hz D in model number: 24 VAC, 50/60 Hz; 24 VDC
Operating voltage range		85% to 110% of rated supply voltage
Power consumption		100 to 240 VAC: 8.5 VA (max.) (E5CN-HR2 at 100 VAC: 3.0 VA) 24 VAC/VDC: 5.5 VA (24 VAC)/3.5 W (24 VDC) (max.) (E5CN-HR2D at 24 VAC: 2.7 VA)
Sensor input		Any of the following can be selected (i.e., fully universal input). Thermocouple: K, J, T, E, L, U, N, R, S, B, W, or PL II Platinum resistance thermometer: Pt100 or JPt100 Current input: 4 to 20 mA or 0 to 20 mA Voltage input: 1 to 5 V, 0 to 5 V, or 0 to 10 V
Input impedance		Current input: 150 Ω max., Voltage input: 1 MΩ min. (Use a 1:1 connection when connecting the ES2-HB.)
Control method		ON/OFF control or 2-PID control (with auto-tuning)
Control output	Relay output	SPST-NO, 250 VAC, 3 A (resistive load), electrical life: 100,000 operations, minimum applicable load: 5 V, 10 mA
	Voltage output (for driving SSR)	Output voltage: 12 VDC ±15% (PNP), max. load current: 21 mA, with short-circuit protection circuit
	Current output	4 to 20 mA DC/0 to 20 mA DC, load: 600 Ω max., resolution: approx. 10,000 *
	Linear voltage output	0 to 10 VDC (load: 1 kΩ min.), Resolution: Approx. 10,000
Auxiliary output	Number of outputs	2 max.
	Output specifications	Relay output: SPST-NO, 250 VAC, 3 A (resistive load), electrical life: 100,000 operations, minimum applicable load: 5 V, 10 mA
Event input	Number of outputs	2
	External contact input specifications	Contact input: ON: 1 kΩ max., OFF: 100 kΩ min.
		Non-contact input: ON: Residual voltage: 1.5 V max., OFF: Leakage current: 0.1 mA max. Current flow: Approx. 7 mA per contact
Logic operations	Number of operations	8 max. (Combinations can be made using work bits.)
	Operations	<ul style="list-style-type: none"> Logic operation: Any of the following four patterns can be selected. The input status may be inverted. (A and B) or (C and D), (A or C) and (B or D), A or B or C or D, A and B and C and D (A, B, C, and D are four inputs.) Delay: ON delay or OFF delay for the results of the logic operation given above. Setting time: 0 to 9999 s or 0 to 9999 min Output inversion: Possible
		Outputs
	Work bit assignments	Any of the following can be assigned to up to eight work bits (logic operation results): Event input operations, auxiliary outputs, or control outputs.
Transfer outputs	Number of outputs	1 max.
	Output specifications	Current output: 4 to 20 mA DC, Load: 600 Ω max., Resolution at 4 to 20 mA: Approx. 10,000
RSP input		Not supported
Setting method		Digital setting using front panel keys
Indication method		11-segment digital display and individual indicators (7-segments displays also possible) Character height: PV: 11 mm, SV: 6.5 mm
Bank switching		Supported (number of banks: 8) Local SP, alarm settings, PID sets (PID constants, MV upper limit, MV lower limit, etc.)
Other functions		Manual output, heating/cooling control, loop burnout alarm, SP ramp, other alarm functions, heater burnout detection, 40% AT, 100% AT, MV limiter, input digital filter, self-tuning, temperature input shift, run/stop, protection functions, control output ON/OFF counter, extraction of square root, MV change rate limit, PV/SV status display, logic operations, automatic cooling coefficient adjustment
Ambient operating temperature		-10 to 55°C (with no condensation or icing), for 3-year warranty: -10 to 50°C
Ambient operating humidity		25% to 85%
Storage temperature		-25 to 65°C (with no condensation or icing)

* For models with current outputs, control output 1 can be used as a transfer output.

E5CN
E5CN-U (48 x 48 mm)

E5AN (96 x 96 mm)
E5EN (48 x 96 mm)

E5CN-H (48 x 48 mm)

E5AN-H (96 x 96 mm)
E5EN-H (48 x 96 mm)

Operation

Safety Precautions

Input Ranges

Thermocouple/Platinum Resistance Thermometer/Analog Input (Fully Universal Inputs)

Input type	Platinum resistance thermometer					Thermocouple															Analog input																																										
	Pt100			JPt100		K			J			T			E			L			U			N			R			S			B			W			PL II			4 to 20 mA	0 to 20 mA	1 to 5 V	0 to 5 V	0 to 10 V																	
Temperature range (°C)	850.0			500.0		100.0			200.00		500.0			1300.0			500.0			200.00			850.0			400.0			400.0			600.0			850.0			400.0			400.0			1300.0			1700.0			1700.0			1800.0			2300.0							
	-200.0 -199.9			-199.9		-200.0			-20.0 -50.0 -100.0			-20.0 -50.0			-200.0 -199.9			-200.0			-200.0 -199.9 -200.0			0.0			0.0			100.0			0.0			0.0			Usable in the following ranges by scaling: -19999 to 32400, -1999.9 to 3240.0, -199.99 to 324.00, or -19.999 to 32.400																								
Setting number	0	1	2	24	3	4	5	6	21	7	8	22	9	10	23	11	12	13	14	15	16	17	18	19	20	25	26	27	28	29																																	

Shaded settings are the default settings.

The applicable standards for the input types are as follows:

K, J, T, E, N, R, S, B: JIS C 1602-1995, IEC 584-1

L: Fe-CuNi, DIN 43710-1985

U: Cu-CuNi, DIN 43710-1985

W: W5Re/W26Re, ASTM E988-1990

JPt100: JIS C 1604-1989, JIS C 1606-1989

Pt100: JIS C 1604-1997, IEC 751

PL II: According to Platinel II electromotive force charts from BASF (previously Engelhard)

E5CN
E5CN-U (48 x 48 mm)

E5AN (96 x 96 mm)
E5EN (48 x 96 mm)

E5CN-H (48 x 48 mm)

E5AN-H (96 x 96 mm)
E5EN-H (48 x 96 mm)

Operation

Safety Precautions

E5CN-H

Alarm Outputs

Each alarm can be independently set to one of the following 13 alarm types. The default is 2: *Upper limit*. Auxiliary outputs are allocated for alarms. ON delays and OFF delays (0 to 999 s) can also be specified.

Note: For models with heater burnout, SSR failure, and heater overcurrent detection, alarm 1 will be an OR output of the alarm selected from the following alarm types and the alarms for heater burnout, SSR failure, and heater overcurrent. To output only a heater burnout alarm, SSR failure alarm, and heater overcurrent alarm for alarm 1, set the alarm type to 0 (i.e., no alarm function).

Set value	Alarm type	Alarm output operation	
		When X is positive	When X is negative
0	Alarm function OFF	Output OFF	
1 *1	Upper- and lower-limit		*2
2	Upper limit		
3	Lower limit		
4 *1	Upper- and lower-limit range		*3
5 *1	Upper- and lower-limit with standby sequence		*4
6	Upper-limit with standby sequence		
7	Lower-limit with standby sequence		
8	Absolute-value upper-limit		
9	Absolute-value lower-limit		
10	Absolute-value upper-limit with standby sequence		
11	Absolute-value lower-limit with standby sequence		
12	LBA (for alarm 1 only)	---	
13	PV change rate alarm	---	

*1. With set values 1, 4 and 5, the upper and lower limit values can be set independently for each alarm type, and are expressed as "L" and "H."

*2. Set value: 1, Upper- and lower-limit alarm

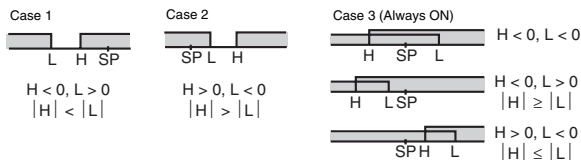

*3. Set value: 4, Upper- and lower-limit range

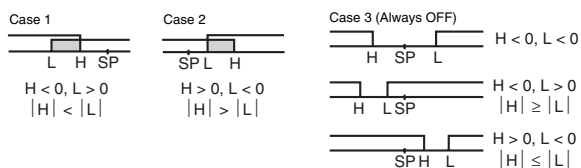

*4. Set value: 5, Upper- and lower-limit with standby sequence
For Upper- and Lower-Limit Alarm Described Above

- Case 1 and 2
Always OFF when the upper-limit and lower-limit hysteresis overlaps.

- Case 3: Always OFF

*5. Set value: 5, Upper- and lower-limit with standby sequence
Always OFF when the upper-limit and lower-limit hysteresis overlaps.

Characteristics

Indication accuracy	Thermocouple: ($\pm 0.1\%$ of indicated value or $\pm 1^\circ\text{C}$, whichever is greater) ± 1 digit max. *1 Platinum resistance thermometer: ($\pm 0.1\%$ of indicated value or $\pm 0.5^\circ\text{C}$, whichever is greater) ± 1 digit max. Analog input: $\pm 0.1\%$ FS ± 1 digit max. CT input: $\pm 5\%$ FS ± 1 digit max.	
Transfer output accuracy	$\pm 0.3\%$ FS max.	
Influence of temperature *2	Thermocouple input (R, S, B, W, PLII): ($\pm 1\%$ of PV or $\pm 10^\circ\text{C}$, whichever is greater) ± 1 digit max. Other thermocouple input: ($\pm 1\%$ of PV or $\pm 4^\circ\text{C}$, whichever is greater) ± 1 digit max. *3	
Influence of voltage *2	Platinum resistance thermometer: ($\pm 1\%$ of PV or $\pm 2^\circ\text{C}$, whichever is greater) ± 1 digit max. Analog input: ($\pm 1\%$ FS) ± 1 digit max.	
Input sampling period	60 ms	
Hysteresis	Temperature input: 0.1 to 3240.0°C or °F (in units of 0.1°C or °F) Analog input: 0.01% to 99.99% FS (in units of 0.01% FS)	
Proportional band (P)	Temperature input: 0.1 to 3240.0°C or °F (in units of 0.1 °C or °F) Analog input: 0.1% to 999.9% FS (in units of 0.1% FS)	
Integral time (I)	0.0 to 3240.0 s (in units of 0.1 s)	
Derivative time (D)	0.0 to 3240.0 s (in units of 0.1 s)	
Control period	0.5, 1 to 99 s (in units of 1 s)	
Manual reset value	0.0 to 100.0% (in units of 0.1%)	
Alarm setting range	-19999 to 32400 (decimal point position depends on input type)	
Affect of signal source resistance	Thermocouple: 0.1°C/Ω max. (100 Ω max.) Platinum resistance thermometer: 0.1°C/Ω max. (10 Ω max.)	
Insulation resistance	20 MΩ min. (at 500 VDC)	
Dielectric strength	2,300 VAC, 50 or 60 Hz for 1 min (between terminals with different charge)	
Vibration resistance	Malfunction	10 to 55 Hz, 20 m/s ² for 10 min each in X, Y, and Z directions
	Destruction	10 to 55 Hz, 0.75-mm single amplitude for 2 hrs each in X, Y, and Z directions
Shock resistance	Malfunction	100 m/s ² , 3 times each in X, Y, and Z directions
	Destruction	300 m/s ² , 3 times each in X, Y, and Z directions
Weight	Controller: Approx. 150 g, Mounting Bracket: Approx. 10 g	
Degree of protection	Front panel: IP66, Rear case: IP20, Terminals: IP00	
Memory protection	Non-volatile memory (number of writes: 1,000,000 times)	
Setup Tool	CX-Thermo version 4.0 or higher	
Setup Tool port	Provided on the bottom of the E5CN-H. Use this port to connect a computer to the E5CN-H. An E58-CIFQ1 USB-Serial Conversion Cable is required to connect the computer to the E5CN-H. *4	
Standards	Approved standards	UL 61010-1, CSA C22.2 No. 1010-1
	Conformed standards	EN 61010-1 (IEC 61010-1): Pollution level 2, overcurrent category II
EMC	EMI: Radiated Interference Electromagnetic Field Strength: Noise Terminal Voltage: EMS: ESD Immunity: Electromagnetic Field Immunity: Burst Noise Immunity: Conducted Disturbance Immunity: Surge Immunity: Power Frequency Magnetic Field Immunity: Voltage Dip/Interrupting Immunity:	EN 61326 EN 55011 Group 1, class A EN 55011 Group 1, class A EN 61326 EN 61000-4-2 EN 61000-4-3 EN 61000-4-4 EN 61000-4-6 EN 61000-4-5 EN 61000-4-8 EN 61000-4-11

*1. The indication accuracy of K thermocouples in the -200 to 1300°C range, T and N thermocouples at a temperature of -100°C max., and U and L thermocouples at any temperatures is $\pm 2^\circ\text{C} \pm 1$ digit max. The indication accuracy of the B thermocouple at a temperature of 400°C max. is not specified. The indication accuracy of B thermocouples in the 400 to 800°C range is $\pm 3^\circ\text{C}$ max. The indication accuracy of the R and S thermocouples at a temperature of 200°C max. is $\pm 3^\circ\text{C} \pm 1$ digit max. The indication accuracy of W thermocouples is ± 0.3 of PV or $\pm 3^\circ\text{C}$, whichever is greater, ± 1 digit max. The indication accuracy of PL II thermocouples is ± 0.3 of PV or $\pm 2^\circ\text{C}$, whichever is greater, ± 1 digit max.

*2. Ambient temperature: -10°C to 23°C to 55°C , Voltage range: -15% to 10% of rated voltage

*3. K thermocouple at -100°C max.: $\pm 10^\circ\text{C}$ max.

*4. External communications (RS-232C or RS-485) and cable communications for the Setup Tool can be used at the same time.

E5CN
E5CN-U (48 x 48 mm)E5AN (96 x 96 mm)
E5EN (48 x 96 mm)

E5CN-H (48 x 48 mm)

E5AN-H (96 x 96 mm)
E5EN-H (48 x 96 mm)

Operation

Safety Precautions

E5CN-H

E5CN
E5CN-U (48 x 48 mm)

USB-Serial Conversion Cable

Applicable OS	Windows 2000, XP, or Vista
Applicable software	Thermo Mini, CX-Thermo version 4.0 or higher
Applicable models	E5AN/E5EN/E5CN/E5CN-U/ E5AN-H/E5EN-H/E5CN-H
USB interface standard	Conforms to USB Specification 1.1.
DTE speed	38400 bps
Connector specifications	Computer: USB (type A plug) Temperature Controller: Setup Tool port (on bottom of Controller)
Power supply	Bus power (Supplied from USB host controller.)
Power supply voltage	5 VDC
Current consumption	70 mA
Ambient operating temperature	0 to 55°C (with no condensation or icing)
Ambient operating humidity	10% to 80%
Storage temperature	-20 to 60°C (with no condensation or icing)
Storage humidity	10% to 80%
Altitude	2,000 m max.
Weight	Approx. 100 g

E5AN (96 x 96 mm)
E5EN (48 x 96 mm)

E5CN-H (48 x 48 mm)

Note: A driver must be installed in the personal computer. Refer to installation information in the operation manual for the Conversion Cable.

Communications Specifications

Transmission line connection method	RS-485: Multipoint RS-232C: Point-to-point
Communications	RS-485 (two-wire, half duplex)/RS-232C
Synchronization method	Start-stop synchronization
Protocol	CompoWay/F, SYSWAY, or Modbus
Baud rate	1200, 2400, 4800, 9600, 19200, 38400, or 57600 bps
Transmission code	ASCII (CompoWay/F, SYSWAY) RTU (Modbus)
Data bit length *	7 or 8 bits
Stop bit length *	1 or 2 bits
Error detection	Vertical parity (none, even, odd) Frame check sequence (FCS) with SYSWAY Block check character (BCC) with CompoWay/F or CRC-16 Modbus
Flow control	None
Interface	RS-485, RS-232C
Retry function	None
Communications buffer	217 bytes
Communications response wait time	0 to 99 ms Default: 20 ms

* The baud rate, data bit length, stop bit length, and vertical parity can be individually set using the Communications Setting Level.

E5AN-H (96 x 96 mm)
E5EN-H (48 x 96 mm)

Operation

Safety Precautions

Current Transformer (Order Separately) Ratings

Dielectric strength	1,000 VAC for 1 min
Vibration resistance	50 Hz, 98 m/s ²
Weight	E54-CT1: Approx. 11.5 g, E54-CT3: Approx. 50 g
Accessories (E54-CT3 only)	Armatures (2) Plugs (2)

Heater Burnout Alarms, SSR Failure Alarms, and Heater Overcurrent Alarms

CT input (for heater current detection)	Models with detection for single-phase heaters: One input Models with detection for single-phase or three-phase heaters: Two inputs
Maximum heater current	50 A AC
Input current indication accuracy	±5% FS ±1 digit max.
Heater burnout alarm setting range *1	0.1 to 49.9 A (in units of 0.1 A) Minimum detection ON time: 100 ms
SSR failure alarm setting range *2	0.1 to 49.9 A (in units of 0.1 A) Minimum detection OFF time: 100 ms
Heater overcurrent alarm setting range *3	0.1 to 49.9 A (in units of 0.1 A) Minimum detection ON time: 100 ms

- *1. For heater burnout alarms, the heater current will be measured when the control output is ON, and the output assigned to the alarm 1 function will turn ON if the heater current is lower than the set value (i.e., heater burnout detection current value).
- *2. For SSR failure alarms, the heater current will be measured when the control output is OFF, and the output assigned to the alarm 1 function will turn ON if the heater current is higher than the set value (i.e., SSR failure detection current value).
- *3. For heater overcurrent alarms, the heater current will be measured when the control output is ON, and the output assigned to the alarm 1 function will turn ON if the heater current is higher than the set value (i.e., heater overcurrent detection current value).

Electrical Life Expectancy Curve for Relays (Reference Values)

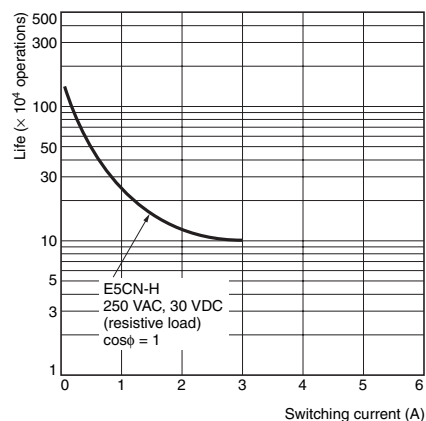

External Connections

- A voltage output (control output, for driving SSR) is not electrically insulated from the internal circuits. When using a grounding thermocouple, do not connect any of the control output terminals to ground. If the control output terminals are connected to ground, errors will occur in the measured temperature values as a result of leakage current.

Controllers

Control output 1

Relay output
250 VAC, 3 A
(resistive load)

Voltage output
(for driving SSR)
12 VDC, 21 mA

Linear voltage output
0 to 10 VAC
Load 1 kΩ max.

Current output
0 to 20 mA DC
4 to 20 mA DC
Load 600 Ω max.

Auxiliary outputs (relay outputs)
250 VAC, 3 A
(resistive load)

A heater burnout alarm, SSR failure, heater overcurrent alarm, or input alarm is sent to the output to which the alarm 1 function is assigned.

- 100 to 240 VAC
- 24 VAC/VDC (no polarity)

Option Units

E53-CNBN2
Event Inputs

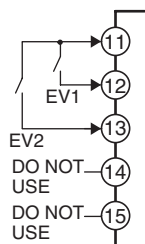

E53-CNQBN2
Event Inputs and Control Output 2

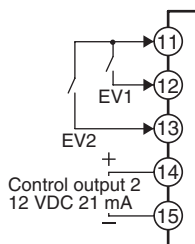

E53-CNHBN2
Event Inputs and CT

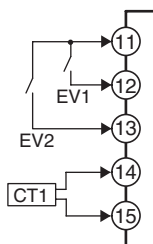

E53-CNBFN2
Event Inputs and Transfer Output

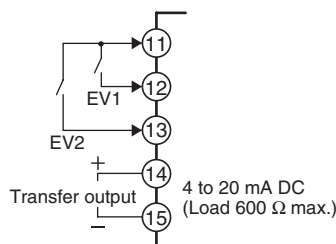

E53-CNQH2N2
Control Output 2 and CT2

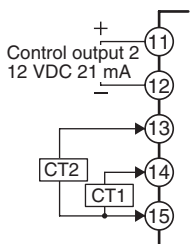

E53-CNQFN2
Control Output 2 and Transfer Output

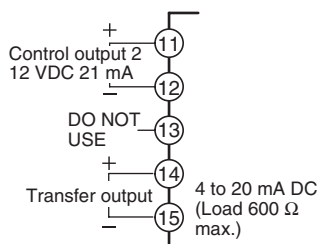

E53-CN01N2
Communications (RS-232C)

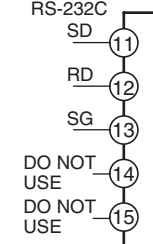

E53-CNH01N2
Communications (RS-232C) and CT

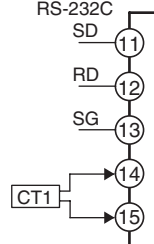

E53-CNQ01N2
Communications (RS-232C) and Control Output 2

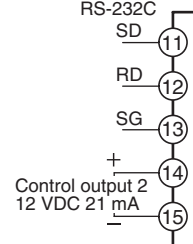

E53-CN03N2
Communications (RS-485)

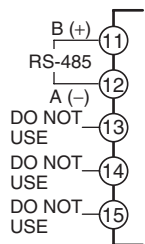

E53-CNQ03N2
Communications (RS-485) and Control Output 2

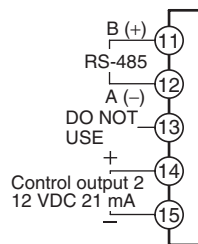

E53-CNH03N2
Communications (RS-485) and CT

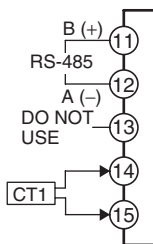

E53-CNHH03N2
Communications (RS-485) and CT2

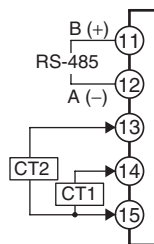

E53-CNQH2N2
Control Output 2 and CT

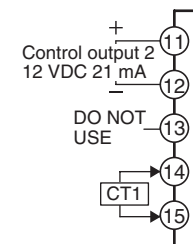

Note: Wire all voltage input terminals correctly. The Controller may fail if voltage input terminals are wired incorrectly.

E5CN (48 x 48 mm)
E5CN-U (48 x 48 mm)

E5AN (96 x 96 mm)
E5EN (48 x 96 mm)

E5CN-H (48 x 48 mm)

E5AN-H (96 x 96 mm)
E5EN-H (48 x 96 mm)

Operation

Safety Precautions

E5CN-H

Nomenclature

E5CN-H

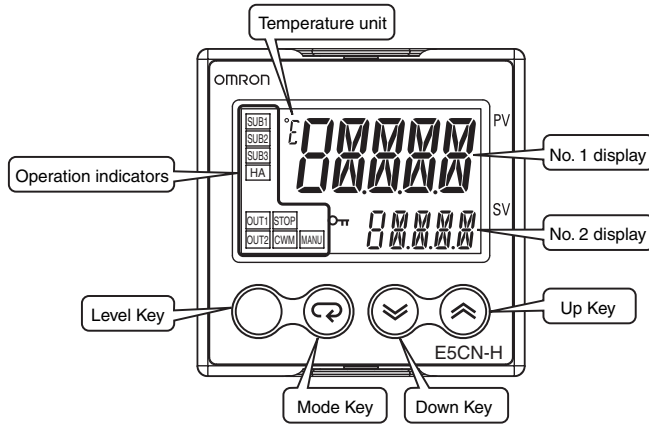

Dimensions

(Unit: mm)

E5CN-H

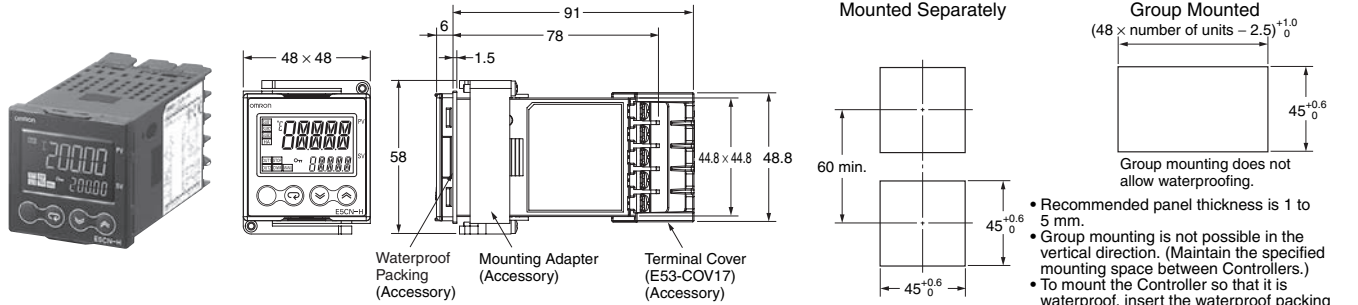

Note: The terminal block cannot be removed.

Accessories (Order Separately)

USB-Serial Conversion Cable

E58-CIFQ1

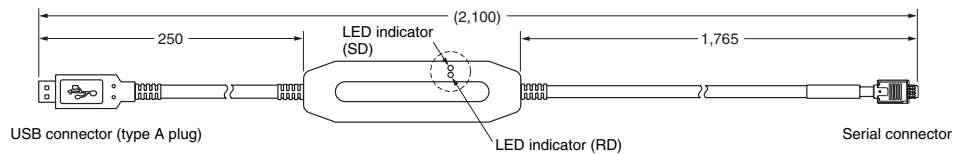
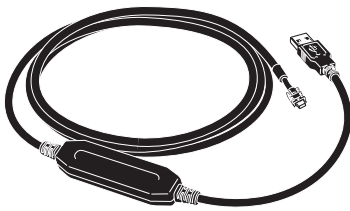

Operation

Safety Precautions

E5CN (48 x 48 mm)
E5CN-U

E5AN (96 x 96 mm)
E5EN (48 x 96 mm)

E5CN-H (48 x 48 mm)

E5AN-H (96 x 96 mm)
E5EN-H (48 x 96 mm)

Terminal Cover E53-COV17

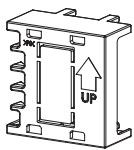

Note: The E53-COV10 can not be used.

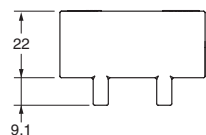
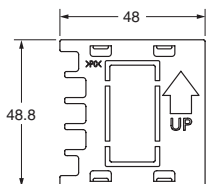

Waterproof Packing Y92S-29 (for DIN 48 × 48)

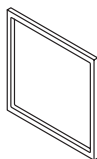

Order the Waterproof Packing separately if it becomes lost or damaged.

The Waterproof Packing can be used to achieve an IP66 degree of protection.

(Deterioration, shrinking, or hardening of the waterproof packing may occur depending on the operating environment. Therefore, periodic replacement is recommended to ensure the level of waterproofing specified in IP66. The time for periodic replacement depends on the operating environment. Be sure to confirm this point at your site. Consider one year a rough standard. OMRON shall not be liable for the level of water resistance if the customer does not perform periodic replacement.)

The Waterproof Packing does not need to be attached if a waterproof structure is not required.

Current Transformers

E54-CT1

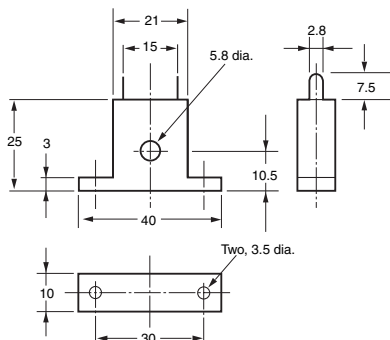

E54-CT1

Thru-current (I_o) vs. Output Voltage (E_o) (Reference Values)

Maximum continuous heater current: 50 A (50/60 Hz)

Number of windings: 400±2

Winding resistance: 18±2 Ω

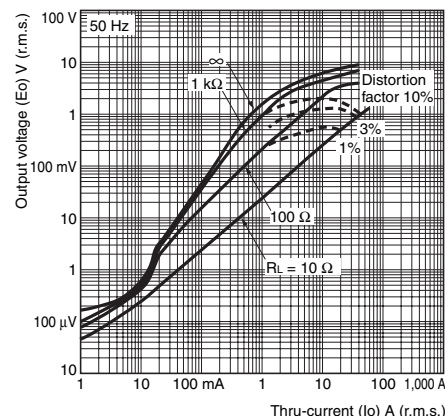

E54-CT3

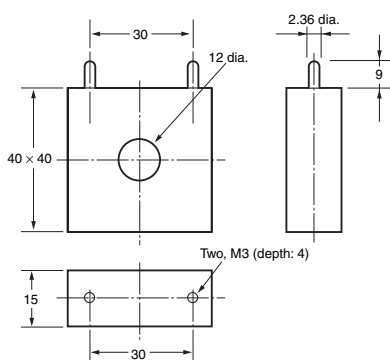

E54-CT3

Thru-current (I_o) vs. Output Voltage (E_o) (Reference Values)

Maximum continuous heater current: 120 A (50/60 Hz)

(Maximum continuous heater current for an OMRON Temperature Controller is 50 A.)

Number of windings: 400±2

Winding resistance: 8±0.8 Ω

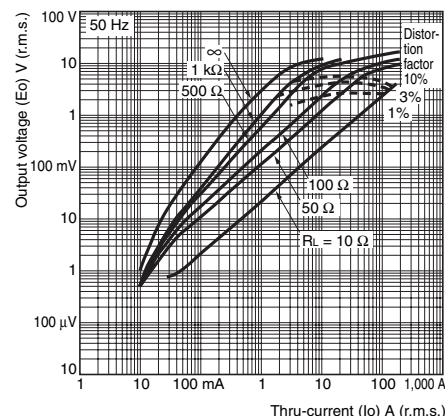

E54-CT3 Accessory

• Armature

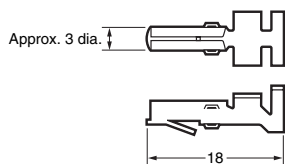

• Plug

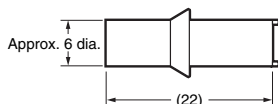

Connection Example

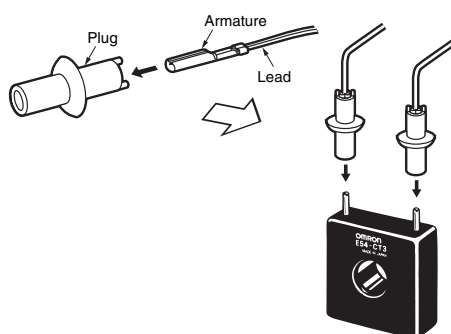

E5CN
E5CN-U (48 x 48 mm)

E5AN (96 x 96 mm)
E5EN (48 x 96 mm)

E5CN-H (48 x 48 mm)

E5AN-H (96 x 96 mm)
E5EN-H (48 x 96 mm)

Operation

Safety Precautions

E5CN-H

E5CN
E5CN-U (48 x 48 mm)

Adapter

Y92F-45 Note: Use this Adapter when the panel has already been prepared for the E5B□.

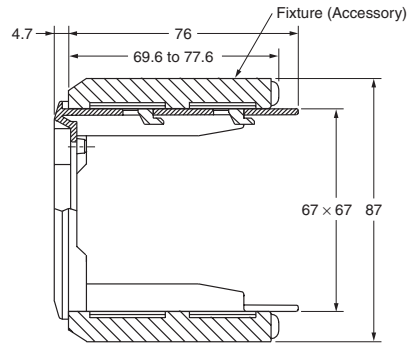
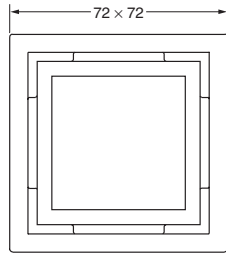
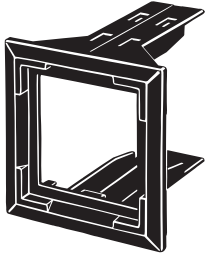

E5AN (96 x 96 mm)
E5EN (48 x 96 mm)

Mounted to E5CN-H

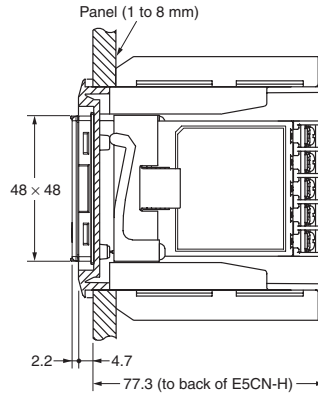
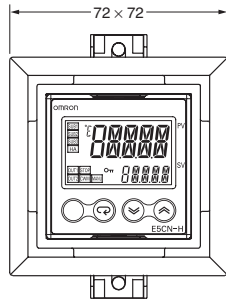
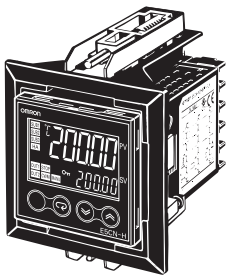

E5CN-H (48 x 48 mm)

E5AN-H (96 x 96 mm)
E5EN-H (48 x 96 mm)

Operation

Safety Precautions

Advanced Digital Temperature Controller E5AN-H/E5EN-H (96 x 96 mm and 48 x 96 mm)

A New High-performance Controller: High Resolution, High Speed, and High Input Accuracy.

Logic Operations and Preventive Maintenance Function. Plus Infrared Port on Front Panel.

- High-resolution display with 5 digits/0.01°C display.
- High-speed sampling cycle of 60 ms.
- High Accuracy
Thermocouple/Pt input: $\pm 0.1\%$ of PV
Analog input: $\pm 0.1\%$ FS
- Universal inputs on all models (thermocouple, PT, or analog input) to handle various sensors with one Controller. Models also available with Remote SP.
- A PV/SV-status display function can be set to automatically alternate between displaying the status of the Temperature Controller (auto/manual, RUN/STOP, and alarms) and the PV or SV.
- Flexible contact outputs with logic operations (AND, OR, and delays) set from the Support Software (CX-Thermo Ver. 4.0)
- Preventive maintenance for relays in the Temperature Controller using a Control Output ON/OFF Counter.
- Model available with position-proportional control



UL US CE

96 x 96 mm
E5AN-H

48 x 96 mm
E5EN-H

NEW

Refer to Safety Precautions on page 66.

Main I/O Functions

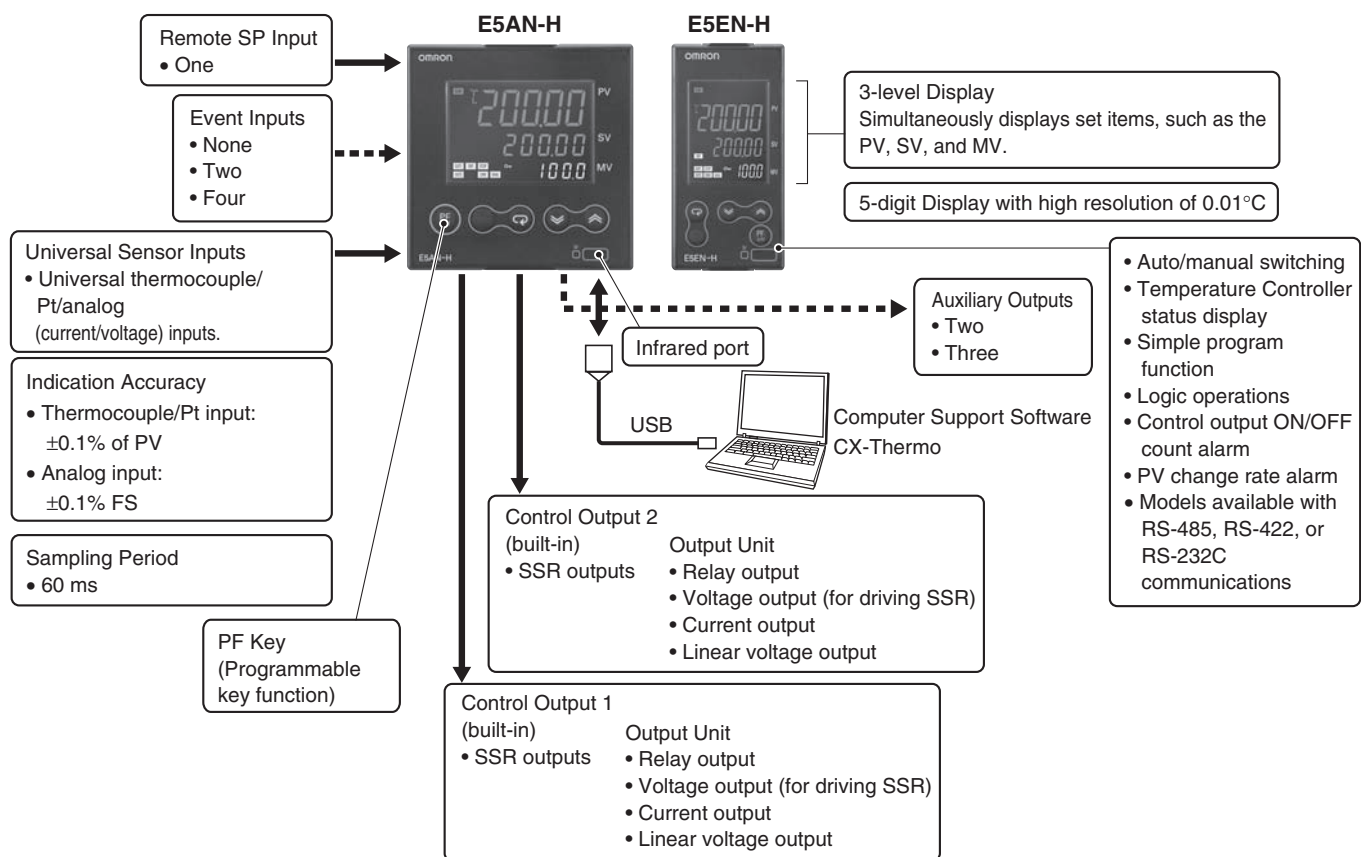

E5CN (96 x 96 mm)
E5CN-U (48 x 48 mm)

E5AN (96 x 96 mm)
E5EN (48 x 96 mm)

E5CN-H (48 x 48 mm)

E5AN-H (96 x 96 mm)
E5EN-H (48 x 96 mm)

Operation

Safety Precautions

E5AN-H/E5EN-H

Lineup



Note: The Controller can be used for heating/cooling control even if only 1 control output is used.

Model Number Structure

Model Number Legend

Controllers

E5AN/E5EN- M - -500
 1 2 3 4 5 6 7 8 9 10 11

1. Type

H: Advanced

2. Control Mode

Blank: Standard or heating/cooling control
 P: Position-proportional control

3. Control Output 1

A: Control Output Unit
 R: Relay output
 S: SSR output

4. Control Output 2

A: Control Output Unit
 R: Relay output
 S: SSR output

5. Auxiliary Outputs

2: Two outputs
 3: Three outputs

6. Option 1

Blank: None
 H: Heater burnout/SSR failure/Heater overcurrent detection (CT1)
 HH: Heater burnout/SSR failure/Heater overcurrent detection (CT2)

7. Option 2

B: Two event inputs
 BF: Event input + Transfer output

8. Option 3

M: Option Unit can be mounted.

9. Power Supply Voltage

Blank: 100 to 240 VAC
 D: 24 VAC/VDC

10. Case Color

Blank: Black
 W: Silver

11. Terminal Cover

-500: With Terminal Cover

Option Units

E53-
 1

1. Function

EN01: RS-232C communications
 EN02: RS-422 communications
 EN03: RS-485 communications
 AKB: Event input

Output Units

E53-
 1 2

1. Control Output

R: Relay output
 Q: Voltage output (for driving SSR)
 Q3: Voltage output (for driving SSR) + 24 VDC (NPN)
 Q4: Voltage output (for driving SSR) + 24 VDC (PNP)
 C3: Current output + 4 to 20 mA DC
 C3D: Current output + 0 to 20 mA DC
 V34: Linear voltage output + 0 to 10 VDC
 V35: Linear voltage output + 0 to 5 VDC

2. Version

Blank: Available for E5AN-H/E5EN-H and E5AK/E5EK.
 N: Available only for E5AN-H/E5EN-H.

Operation

Safety Precautions

This data sheet is provided as a guideline for selecting products. Be sure to refer to the following user manuals for application precautions and other information required for operation before attempting to use the product.

E5CN-H/E5AN-H/E5EN-H Digital Controllers User's Manual Advanced Type (Cat. No. H157)

E5CN-H/E5AN-H/E5EN-H Digital Controllers Communications Manual Advanced Type (Cat. No. H159)

Ordering Information

E5AN-H

Size	Case color	Power supply voltage	Control method	Auxiliary output	Control output 1/2	Heater burnout	Optional functions			Model
							Event inputs	Transfer output	RSP	
1/4 DIN 96 × 96 × 78 (W × H × D)	Black	100 to 240 VAC	Basic	2	Control Output Unit × 2	1	2		4 to 20-mA input	E5AN-HAA2HBM-500
					SSR outputs × 2	1	2		4 to 20-mA input	E5AN-HSS2HBM-500
				Control Output Unit × 2	2	2	4 to 20-mA output	4 to 20-mA input	E5AN-HAA2HHBFM-500	
				SSR outputs × 2	2	2	4 to 20-mA output	4 to 20-mA input	E5AN-HSS2HHBFM-500	
			3	Control Output Unit × 2		2	4 to 20-mA output	4 to 20-mA input	E5AN-HAA3BFM-500	
				SSR outputs × 2		2	4 to 20-mA output	4 to 20-mA input	E5AN-HSS3BFM-500	
		Valve	2	Relay outputs × 2		2		4 to 20-mA input	E5AN-HPRR2BM-500	
				Relay outputs × 2		2	4 to 20-mA output	4 to 20-mA input	E5AN-HPRR2BFM-500	
		24 VAC/ VDC	Basic	2	Control Output Unit × 2	1	2		4 to 20-mA input	E5AN-HAA2HBMD-500
					SSR outputs × 2	1	2		4 to 20-mA input	E5AN-HSS2HBMD-500
				Control Output Unit × 2	2	2	4 to 20-mA output	4 to 20-mA input	E5AN-HAA2HHBFMD-500	
				SSR outputs × 2	2	2	4 to 20-mA output	4 to 20-mA input	E5AN-HSS2HHBFMD-500	
	3		Control Output Unit × 2		2	4 to 20-mA output	4 to 20-mA input	E5AN-HAA3BFMD-500		
			SSR outputs × 2		2	4 to 20-mA output	4 to 20-mA input	E5AN-HSS3BFMD-500		
	Valve	2	Relay outputs × 2		2		4 to 20-mA input	E5AN-HPRR2BMD-500		
			Relay outputs × 2		2	4 to 20-mA output	4 to 20-mA input	E5AN-HPRR2BFMD-500		
	Silver	Basic	2	Control Output Unit × 2	1	2		4 to 20-mA input	E5AN-HAA2HBM-W-500	
				Control Output Unit × 2	2	2	4 to 20-mA output	4 to 20-mA input	E5AN-HAA2HHBFM-W-500	
Control Output Unit × 2				1	2		4 to 20-mA input	E5AN-HAA2HBMD-W-500		

E5CN
E5CN-U (48 x 48 mm)

E5AN (96 x 96 mm)
E5EN (48 x 96 mm)

E5CN-H (48 x 48 mm)

E5AN-H (96 x 96 mm)
E5EN-H (48 x 96 mm)

Operation

Safety Precautions

E5AN-H/E5EN-H

E5CN
E5CN-U (48 x 48 mm)

E5AN (96 x 96 mm)
E5EN (48 x 96 mm)

E5CN-H (48 x 48 mm)

E5AN-H (96 x 96 mm)
E5EN-H (48 x 96 mm)

Operation

Safety Precautions

E5EN-H

Size	Case color	Power supply voltage	Control method	Auxiliary output	Control output 1/2	Heater burn-out	Optional Functions			Model
							Event inputs	Transfer output	RSP	
1/8 DIN 48 × 96 × 78 (W × H × D)	Black	100 to 240 VAC	Basic	2	Control Output Unit × 2	1	2		4 to 20-mA input	E5EN-HAA2HBM-500
					SSR outputs × 2	1	2		4 to 20-mA input	E5EN-HSS2HBM-500
				Control Output Unit × 2	2	2	4 to 20-mA output	4 to 20-mA input	E5EN-HAA2HHBFM-500	
				SSR outputs × 2	2	2	4 to 20-mA output	4 to 20-mA input	E5EN-HSS2HHBFM-500	
			3	Control Output Unit × 2		2	4 to 20-mA output	4 to 20-mA input	E5EN-HAA3BFM-500	
				SSR outputs × 2		2	4 to 20-mA output	4 to 20-mA input	E5EN-HSS3BFM-500	
	Valve	2	Relay outputs × 2		2		4 to 20-mA input	E5EN-HPRR2BM-500		
			Relay outputs × 2		2	4 to 20-mA output	4 to 20-mA input	E5EN-HPRR2BFM-500		
	24 VAC/VDC	Basic	2	2	Control Output Unit × 2	1	2		4 to 20-mA input	E5EN-HAA2HBMD-500
					SSR outputs × 2	1	2		4 to 20-mA input	E5EN-HSS2HBMD-500
				Control Output Unit × 2	2	2	4 to 20-mA output	4 to 20-mA input	E5EN-HAA2HHBFMD-500	
				SSR outputs × 2	2	2	4 to 20-mA output	4 to 20-mA input	E5EN-HSS2HHBFMD-500	
3			Control Output Unit × 2		2	4 to 20-mA output	4 to 20-mA input	E5EN-HAA3BFMD-500		
			SSR outputs × 2		2	4 to 20-mA output	4 to 20-mA input	E5EN-HSS3BFMD-500		
Valve	2	Relay outputs × 2		2		4 to 20-mA input	E5EN-HPRR2BMD-500			
		Relay outputs × 2		2	4 to 20-mA output	4 to 20-mA input	E5EN-HPRR2BFMD-500			
Silver	100 to 240 VAC	Basic	2	Control Output Unit × 2	1	2		4 to 20-mA input	E5EN-HAA2HBM-W-500	
				Control Output Unit × 2	2	2	4 to 20-mA output	4 to 20-mA input	E5EN-HAA2HHBFM-W-500	
				Control Output Unit × 2	1	2		4 to 20-mA input	E5EN-HAA2HBMD-W-500	
		24 VAC/VDC								

Accessories (Order Separately)

Output Units

Output unit	Model	Specifications
Relay output	E53-RN	SPST-NO, 250 VAC, 5 A (resistive load), electrical life: 100,000 operations
Voltage output (for driving SSR)	E53-QN	12 VDC (PNP), max. load current: 40-mA, with short-circuit protection
	E53-Q3	24 VDC (NPN), max. load current: 20-mA, with short-circuit protection
	E53-Q4	24 VDC (PNP), max. load current: 20-mA, with short-circuit protection
Current output	E53-C3N	4 to 20-mA DC, load: 600 Ω max., resolution: approx. 10,000
	E53-C3DN	0 to 20-mA DC, load: 600 Ω max., resolution: approx. 10,000
Linear voltage output	E53-V34N	0 to 10 VDC, load: 1 kΩ min., resolution: approx. 10,000
	E53-V35N	0 to 5 VDC, load: 1 kΩ min., resolution: approx. 10,000

USB-infrared Conversion Cable

Model
E58-CIFIR

USB-Serial Conversion Cable

Model
E58-CIFQ1

Terminal Cover

Connectable models	Model
E5AN-H	E53-COV16
E5EN-H	

Note: The Terminal Cover comes with the E5CN-□□□-500 models.

Waterproof Packing

Connectable models	Model
E5AN-H	Y92S-P4
E5EN-H	Y92S-P5

Note: The Waterproof Packing is included with the Controller.

Current Transformers (CTs)

Hole diameter	Model
5.8 dia.	E54-CT1
12.0 dia.	E54-CT3

CX-Thermo Support Software

Model
EST2-2C-MV4

Specifications

Ratings

Power supply voltage	No D in model number: 100 to 240 VAC, 50/60 Hz D in model number: 24 VAC, 50/60 Hz; 24 VDC		
Operating voltage range	85% to 110% of rated supply voltage		
Power consumption	100 to 240 VAC: 12 VA 24 VAC/VDC: 8.5 VA (24 VAC)/5.5 W (24 VDC)		
Sensor input	Any of the following can be selected. Thermocouple: K, J, T, E, L, U, N, R, S, B, W, or PL II Platinum resistance thermometer: Pt100 or JPt100 Current input: 4 to 20 mA or 0 to 20 mA Voltage input: 1 to 5 V, 0 to 5 V, or 0 to 10 V		
Input impedance	Current input: 150 Ω max., Voltage input: 1 MΩ min. (Use a 1:1 connection when connecting the ES2-HB.)		
Control method	ON/OFF control or 2-PID control (with auto-tuning)		
Control output	Relay output	Output Unit (Install the Output Unit (sold separately).)	
	Voltage output (for driving SSR)		
	Current output		
	Linear voltage output		
	Built-in SSR output		75 to 250 VAC, 1 A (resistive load)
	Relay output for position-proportional control		Relay output: Open and close: SPST-NO, 250 VAC, 1 A (including in-rush current), electrical life: 100,000 operations min. Potentiometer input: Must be between 100 Ω and 2.5 kΩ for maximum open position.
Auxiliary output	Number of outputs	2 or 3 max.	
	Output specifications	Relay output: SPST-NO, 250 VAC, 3 A (resistive load), electrical life: 100,000 operations, minimum applicable load: 5 V, 10 mA	
Event input	Number of outputs	2 or 4 (with an E53-AKB)	
	External contact input specifications	Contact input: ON: 1 kΩ max., OFF: 100 kΩ min.	
		Non-contact input: ON: Residual voltage: 1.5 V max., OFF: Leakage current: 0.1 mA max. Current flow: Approx. 7 mA per contact	
Logic operations	Number of operations	8 max.	
	Operations	<ul style="list-style-type: none"> Logic operation: Any of the following four patterns can be selected. The input status may be inverted. (A and B) or (C and D), (A or C) and (B or D), A or B or C or D, A and B and C and D (A, B, C, and D are four inputs.) Delay: ON delay or OFF delay for the results of the logic operation given above. Setting time: 0 to 9999 s or 0 to 9999 min Output inversion: Possible 	
	Output	One work bit per operation	
	Work bit assignment	Any of The following can be assigned to up to eight work bits (logic operation results): Event input operations, auxiliary outputs, or control outputs.	
Transfer outputs	Number of outputs	1 max. (Depends on model. Models with transfer output (F in model number)	
	Output specifications	Current output: 4 to 20 mA DC, Load: 600 Ω max., Resolution at 4 to 20 mA: Approx. 10,000	
RSP input	Number of inputs	1	
	Signal type	Current input: 4 to 20 mA (input impedance: 150 Ω ±10%)	
	Analog input scaling	Scaling of signal to engineering units (EU) -19,999 to 30,000 (display: 30,000 max.)	
	Accuracy	(±0.2% of FS) ±1 digit max.	
	Input sampling period	60 ms	
Setting method	Set digitally using keys on the front panel or by using the RSP input.		
Indication method	11-segment digital display and individual indicators (7-segments displays also possible) Character height: E5AN-H: PV: 15.8 mm, SV: 9.5 mm, MV: 6.8 mm; E5EN-H: PV: 11.8 mm, SV: 8.1 mm, MV: 5.8 mm Content of 3-level display: PV/SV/MV, PV/SV/Bank No., or soak time remain Number of digits: 5 for PV and SV, 4 for MV		
Bank switching	Supported (number of banks: 8) Local SP, alarm settings, PID sets (PID constants, MV upper limit, MV lower limit, etc.)		
Other functions	Manual output, heating/cooling control, loop burnout alarm, SP ramp, other alarm functions, heater burnout detection, 40% AT, 100% AT, MV limiter, input digital filter, self-tuning, temperature input shift, run/stop, protection functions, control output ON/OFF counter, extraction of square root, MV change rate limit, PV/SV status display, logic operations, automatic cooling coefficient adjustment		
Ambient operating temperature	-10 to 55°C (with no condensation or icing), for 3-year warranty: -10 to 50°C		
Ambient operating humidity	25% to 85%		
Storage temperature	-25 to 65°C (with no condensation or icing)		

E5CN
E5CN-U (48 x 48 mm)E5AN (96 x 96 mm)
E5EN (48 x 96 mm)

E5CN-H (48 x 48 mm)

E5AN-H (96 x 96 mm)
E5EN-H (48 x 96 mm)









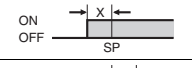

Operation

Safety Precautions

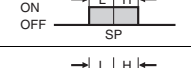
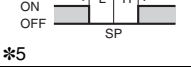
Alarm Outputs

Each alarm can be independently set to one of the following 15 alarm types. The default is 2: *Upper limit*. Auxiliary outputs are allocated for alarms. ON delays and OFF delays (0 to 999 s) can also be specified.

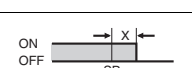
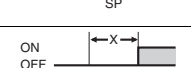
Note: For models with heater burnout, SSR failure, and heater overcurrent detection, alarm 1 will be an OR output of the alarm selected from the following alarm types and the alarms for heater burnout, SSR failure, and heater overcurrent. To output only a heater burnout alarm, SSR failure alarm, and heater overcurrent alarm for alarm 1, set the alarm type to 0 (i.e., no alarm function).

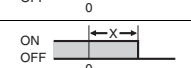
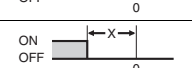
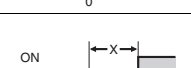
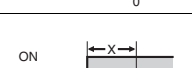
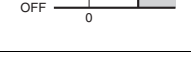
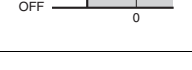
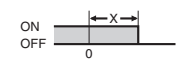
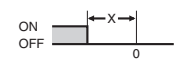
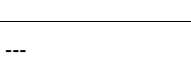
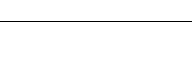
Set value	Alarm type	Alarm output operation	
		When X is positive	When X is negative
0	Alarm function OFF	Output OFF	
1 *1	Upper- and lower-limit	ON OFF 	*2
2	Upper limit	ON OFF 	ON OFF 
3	Lower limit	ON OFF 	ON OFF 
4 *1	Upper- and lower-limit range	ON OFF 	*3
5 *1	Upper- and lower-limit with standby sequence	ON OFF 	*4
6	Upper-limit with standby sequence	ON OFF 	ON OFF 
7	Lower-limit with standby sequence	ON OFF 	ON OFF 
8	Absolute-value upper-limit	ON OFF 	ON OFF 
9	Absolute-value lower-limit	ON OFF 	ON OFF 
10	Absolute-value upper-limit with standby sequence	ON OFF 	ON OFF 
11	Absolute-value lower-limit with standby sequence	ON OFF 	ON OFF 
12	LBA (for alarm 1 only)	---	
13	PV change rate alarm	---	
14	RSP absolute value upper limit *6	ON OFF 	ON OFF 
15	RSP absolute value lower limit *6	ON OFF 	ON OFF 

*1. With set values 1, 4 and 5, the upper and lower limit values can be set independently for each alarm type, and are expressed as “L” and “H.”

*2. Set value: 1, Upper- and lower-limit alarm

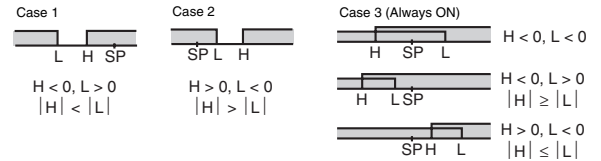

*3. Set value: 4, Upper- and lower-limit range

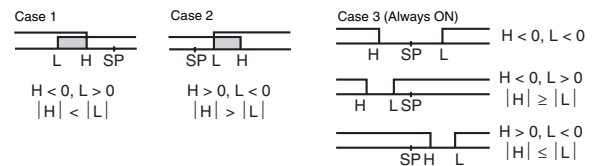

*4. Set value: 5, Upper- and lower-limit with standby sequence For Upper- and Lower-Limit Alarm Described Above

- Case 1 and 2 Always OFF when the upper-limit and lower-limit hysteresis overlaps.
- Case 3: Always OFF

*5. Set value: 5, Upper- and lower-limit with standby sequence Always OFF when the upper-limit and lower-limit hysteresis overlaps.

*6. Displayed when there is a remote SP input.

E5CN
E5CN-U (48 x 48 mm)

E5AN (96 x 96 mm)
E5EN (48 x 96 mm)

E5CN-H (48 x 48 mm)

E5AN-H (96 x 96 mm)
E5EN-H (48 x 96 mm)

Operation

Safety Precautions

E5AN-H/E5EN-H

Characteristics

Indication accuracy		Thermocouple: ($\pm 0.1\%$ of indicated value or $\pm 1^\circ\text{C}$, whichever is greater) ± 1 digit max. *1 Platinum resistance thermometer: ($\pm 0.1\%$ of indicated value or $\pm 0.5^\circ\text{C}$, whichever is greater) ± 1 digit max. Analog input: $\pm 0.1\%$ FS ± 1 digit max. CT input: $\pm 5\%$ FS ± 1 digit max. Potentiometer input: $\pm 5\%$ FS ± 1 digit max.
Transfer output accuracy		$\pm 0.3\%$ FS max.
Influence of temperature *2		Thermocouple input (R, S, B, W, PL II): ($\pm 1\%$ of PV or $\pm 10^\circ\text{C}$, whichever is greater) ± 1 digit max. Other thermocouple input: ($\pm 1\%$ of PV or $\pm 4^\circ\text{C}$, whichever is greater) ± 1 digit max. *3 Platinum resistance thermometer: ($\pm 1\%$ of PV or $\pm 2^\circ\text{C}$, whichever is greater) ± 1 digit max. Analog input: ($\pm 1\%$ FS) ± 1 digit max.
Influence of voltage *2		Analog input: ($\pm 1\%$ FS) ± 1 digit max.
Input sampling period		60 ms
Hysteresis		Temperature input: 0.1 to 3240.0°C or °F (in units of 0.1°C or °F) Analog input: 0.01% to 99.99% FS (in units of 0.01% FS)
Proportional band (P)		Temperature input: 0.1 to 3240.0°C or °F (in units of 0.1°C or °F) Analog input: 0.1% to 999.9% FS (in units of 0.1% FS)
Integral time (I)		0.0 to 3240.0 s (in units of 0.1 s)
Derivative time (D)		0.0 to 3240.0 s (in units of 0.1 s)
Control period		0.5, 1 to 99 s (in units of 1 s)
Manual reset value		0.0 to 100.0% (in units of 0.1%)
Alarm setting range		-19999 to 32400 (decimal point position depends on input type)
Affect of signal source resistance		Thermocouple: 0.1°C/ Ω max. (100 Ω max.) Platinum resistance thermometer: 0.1°C/ Ω max. (10 Ω max.)
Insulation resistance		20 M Ω min. (at 500 VDC)
Dielectric strength		2,300 VAC, 50 or 60 Hz for 1 min (between terminals with different charge)
Vibration resistance	Malfunction	10 to 55 Hz, 20 m/s ² for 10 min each in X, Y, and Z directions
	Destruction	10 to 55 Hz, 0.75-mm single amplitude for 2 hrs each in X, Y, and Z directions
Shock resistance	Malfunction	100 m/s ² , 3 times each in X, Y, and Z directions
	Destruction	300 m/s ² , 3 times each in X, Y, and Z directions
Weight	E5AN-H	Controller: Approx. 310 g, Mounting Bracket: Approx. 100 g
	E5EN-H	Controller: Approx. 260 g, Mounting Bracket: Approx. 100 g
Degree of protection		Front panel: IP66, Rear case: IP20, Terminals: IP00
Memory protection		Non-volatile memory (number of writes: 1,000,000 times)
Setup Tool		CX-Thermo version 4.0 or higher
Setup Tool port		Provided on the bottom of the E5AN-H and E5EN-H. An E58-CIFQ1 USB-Serial Conversion Cable is required to connect the computer to the E5AN-H and E5EN-H. Provided on the front of the E5AN-H and E5EN-H. An E58-CIFIR USB-infrared Conversion Cable is required to connect the computer to the E5AN-H or E5EN-H. *4
Standards	Approved standards	UL 61010-1, CSA C22.2 No. 1010-1
	Conformed standards	EN 61010-1 (IEC 61010-1): Pollution level 2, overcurrent category II
EMC	EMI: Radiated Interference Electromagnetic Field Strength: Noise Terminal Voltage: EMS: ESD Immunity: Electromagnetic Field Immunity: Burst Noise Immunity: Conducted Disturbance Immunity: Surge Immunity: Power Frequency Magnetic Field Immunity: Voltage Dip/Interrupting Immunity:	EN 61326 EN 55011 Group 1, class A EN 55011 Group 1, class A EN 61326 EN 61000-4-2 EN 61000-4-3 EN 61000-4-4 EN 61000-4-6 EN 61000-4-5 EN 61000-4-8 EN 61000-4-11

*1. The indication accuracy of K thermocouples in the -200 to 1300°C range, T and N thermocouples at a temperature of -100°C max., and U and L thermocouples at any temperatures is $\pm 2^\circ\text{C} \pm 1$ digit max. The indication accuracy of the B thermocouple at a temperature of 400°C max. is not specified. The indication accuracy of B thermocouples in the 400 to 800°C range is $\pm 3^\circ\text{C}$ max. The indication accuracy of the R and S thermocouples at a temperature of 200°C max. is $\pm 3^\circ\text{C} \pm 1$ digit max. The indication accuracy of W thermocouples is $\pm 0.3\%$ of PV or $\pm 3^\circ\text{C}$, whichever is greater, ± 1 digit max.

The indication accuracy of PL II thermocouples is $\pm 0.3\%$ of PV or $\pm 2^\circ\text{C}$, whichever is greater, ± 1 digit max.

*2. Ambient temperature: -10°C to 23°C to 55°C , Voltage range: -15% to 10% of rated voltage

*3. K thermocouple at -100°C max.: $\pm 10^\circ\text{C}$ max.

*4. External communications (RS-232C, RS-485, or RS-422) and cable communications for the Setup Tool can be used at the same time.

USB-Serial Conversion Cable

Applicable OS	Windows 2000, XP, or Vista
Applicable software	Thermo Mini, CX-Thermo version 4.0 or higher
Applicable models	E5AN/E5EN/E5CN/E5CN-U/ E5AN-H/E5EN-H/E5CN-H
USB interface standard	Conforms to USB Specification 1.1.
DTE speed	38400 bps
Connector specifications	Computer: USB (type A plug) Temperature Controller: Setup Tool port (on bottom of Controller)
Power supply	Bus power (Supplied from USB host controller.)
Power supply voltage	5 VDC
Current consumption	70 mA
Ambient operating temperature	0 to 55°C (with no condensation or icing)
Ambient operating humidity	10% to 80%
Storage temperature	-20 to 60°C (with no condensation or icing)
Storage humidity	10% to 80%
Altitude	2,000 m max.
Weight	Approx. 100 g

Note: A driver must be installed in the personal computer. Refer to installation information in the operation manual for the Conversion Cable.

Communications Specifications

Transmission line connection method	RS-485, RS-422: Multipoint RS-232C: Point-to-point
Communications	RS-485 (two-wire, half duplex) RS-422 (four-wire, half duplex) or RS-232C
Synchronization method	Start-stop synchronization
Protocol	CompoWay/F, SYSWAY, or Modbus
Baud rate	1200, 2400, 4800, 9600, 19200, 38400, or 57600 bps
Transmission code	ASCII (CompoWay/F, SYSWAY) RTU (Modbus)
Data bit length *	7 or 8 bits
Stop bit length *	1 or 2 bits
Error detection	Vertical parity (none, even, odd) Frame check sequence (FCS) with SYSWAY Block check character (BCC) with CompoWay/F or CRC-16 Modbus
Flow control	None
Interface	RS-485, RS-422, or RS-232C
Retry function	None
Communications buffer	217 bytes
Communications response wait time	0 to 99 ms Default: 20 ms

Note: The baud rate, data bit length, stop bit length, and vertical parity can be individually set using the Communications Setting Level.

Current Transformer (Order Separately) Ratings

Dielectric strength	1,000 VAC for 1 min
Vibration resistance	50 Hz, 98 m/s ²
Weight	E54-CT1: Approx. 11.5 g, E54-CT3: Approx. 50 g
Accessories (E54-CT3 only)	Armatures (2) Plugs (2)

USB-Infrared Conversion Cable

Applicable OS	Windows 2000, XP, or Vista
Applicable software	Thermo Mini, CX-Thermo version 4.0 or higher
Applicable models	E5AN-H/E5EN-H
USB interface standard	Conforms to USB Specification 1.1.
DTE speed	38400 bps
Connector specifications	Computer: USB (type A plug) Temperature Controller: Infrared port (on front of Controller)
Power supply	Bus power (Supplied from USB host controller.)
Power supply voltage	5 VDC
Current consumption	80 mA
Ambient operating temperature	0 to 55°C (with no condensation or icing)
Ambient operating humidity	10% to 80%
Storage temperature	-20 to 60°C (with no condensation or icing)
Storage humidity	10% to 80%
Altitude	2,000 m max.
Weight	Approx. 130 g (with mounting adaptor)

Note: A driver must be installed in the personal computer. Refer to installation information in the operation manual for the Conversion Cable.

Heater Burnout Alarms, SSR Failure Alarms, and Heater Overcurrent Alarms

CT input (for heater current detection)	Models with detection for single-phase heaters: One input Models with detection for single-phase or three-phase heaters: Two inputs
Maximum heater current	50 A AC
Input current indication accuracy	±5% FS ±1 digit max.
Heater burnout alarm setting range *1	0.1 to 49.9 A (in units of 0.1 A) Minimum detection ON time: 100 ms
SSR failure alarm setting range *2	0.1 to 49.9 A (in units of 0.1 A) Minimum detection OFF time: 100 ms
Heater overcurrent alarm setting range *3	0.1 to 49.9 A (in units of 0.1 A) Minimum detection ON time: 100 ms

- *1. For heater burnout alarms, the heater current will be measured when the control output is ON, and the output assigned to the alarm 1 function will turn ON if the heater current is lower than the set value (i.e., heater burnout detection current value).
- *2. For SSR failure alarms, the heater current will be measured when the control output is OFF, and the output assigned to the alarm 1 function will turn ON if the heater current is higher than the set value (i.e., SSR failure detection current value).
- *3. For heater overcurrent alarms, the heater current will be measured when the control output is ON, and the output assigned to the alarm 1 function will turn ON if the heater current is higher than the set value (i.e., heater overcurrent detection current value).

E5CN
E5CN-U (48 x 48 mm)

E5AN (96 x 96 mm)
E5EN (48 x 96 mm)

E5CN-H (48 x 48 mm)

E5AN-H (96 x 96 mm)
E5EN-H (48 x 96 mm)

Operation

Safety Precautions

E5CN
E5CN-U (48 x 48 mm)

Electrical Life Expectancy Curve for Relays (Reference Values)

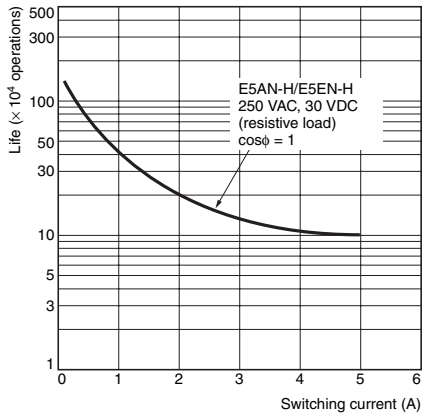

E5AN (96 x 96 mm)
E5EN (48 x 96 mm)

E5CN-H (48 x 48 mm)

E5AN-H (96 x 96 mm)
E5EN-H (48 x 96 mm)

Operation

Safety Precautions

SSR Outputs (OUT1/OUT2) Ratings

- Rated load voltage: 75 to 250 VAC
- Rated load current: 1 A (resistive load)

Note: 1. The load current must be within the derating curve.
2. There is no zero-cross function.

Derating Curve for SSR Outputs (Reference Values)

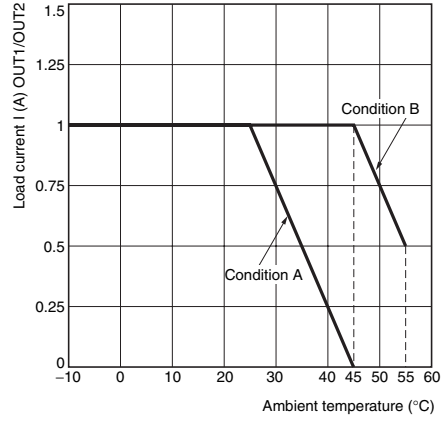

Condition A: SSR outputs 100% ON

Condition B: SSR outputs 50% ON with 2-s control cycle

External Connections

- A voltage output (control output 1, for driving SSR) is not electrically insulated from the internal circuits. When using a grounding thermocouple, do not connect any of the control output terminals to ground. If the control output terminals are connected to ground, errors will occur in the measured temperature values as a result of leakage current. The voltage output (control output 2, for driving SSR) has basic insulation provided for the internal circuit

Controllers

- 100 to 240 VAC
- 24 VAC/VDC (no polarity)

Control outputs 1, 2

Output Unit
Control outputs 1, 2

Relay Outputs
250 VAC, 5 A
(resistive load)

SSR Outputs
75 to 250 VAC, 1A
(resistive load)

Models with Position-
proportional Control
250 VAC, 1 A
(including inrush
current)

Auxiliary outputs 1, 2

Relay output
SPST-NO,
250 VAC, 3 A
(resistive load)

Option Units

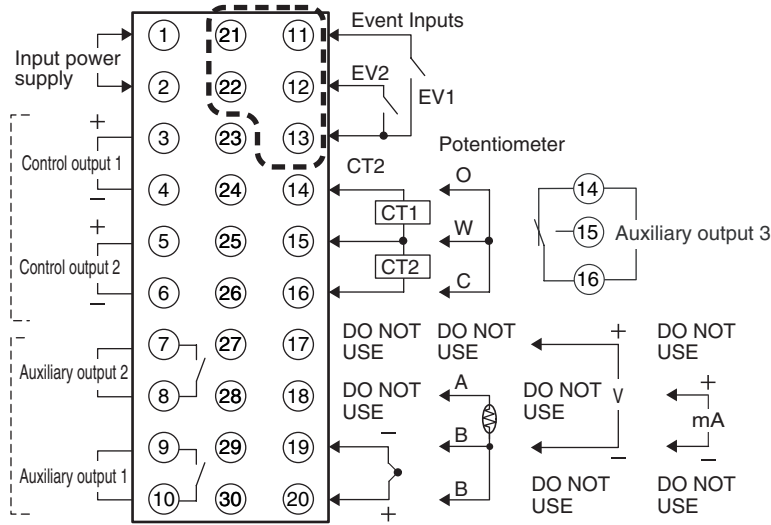
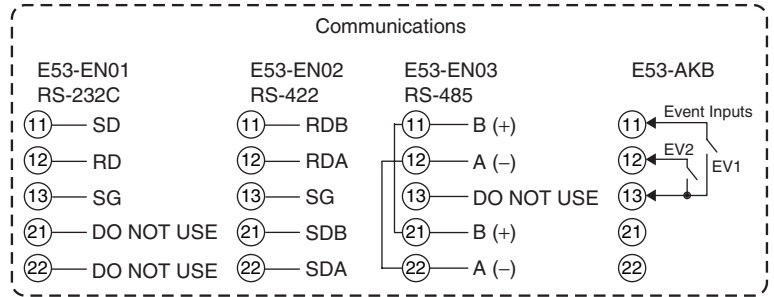

Auxiliary output 3
Relay output
SPDT, 250 VAC, 3 A
(resistive load)

A heater burnout alarm, SSR failure, heater overcurrent alarm, or input alarm is sent to the output to which the alarm 1 function is assigned.

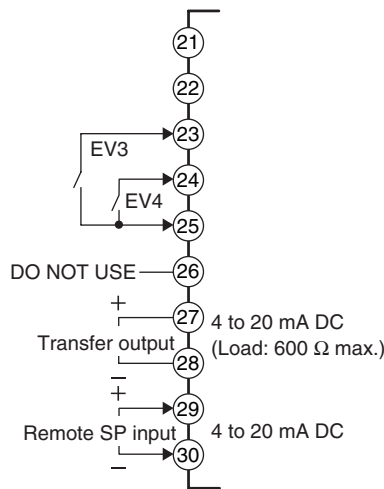

Note: Wire all voltage input terminals correctly. The Controller may fail if voltage input terminals are wired incorrectly.

E5CN
E5CN-U (48 x 48 mm)

E5AN (96 x 96 mm)
E5EN (48 x 96 mm)

E5CN-H (48 x 48 mm)

E5AN-H (96 x 96 mm)
E5EN-H (48 x 96 mm)

Operation

Safety Precautions

E5AN-H/E5EN-H

Nomenclature

E5AN-H

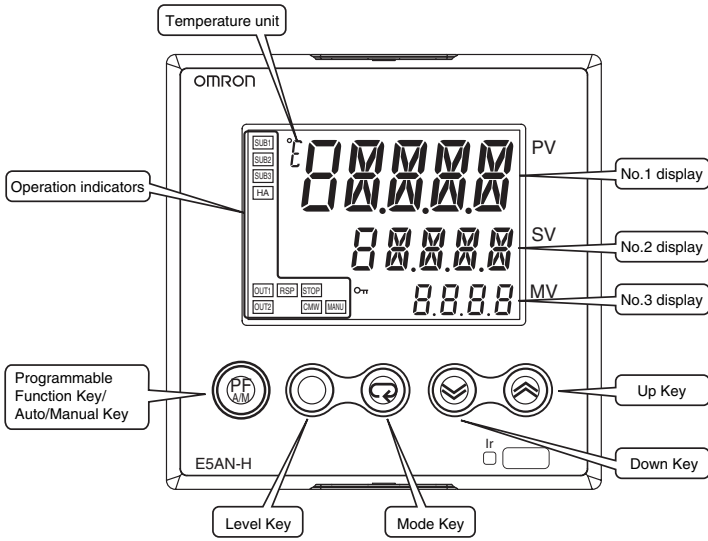

E5EN-H

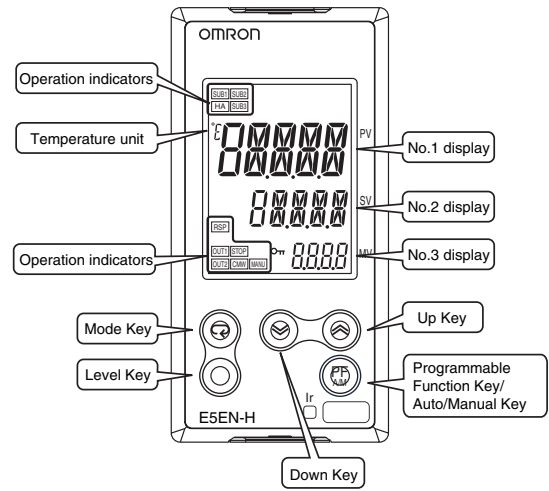

Dimensions

(Unit: mm)

E5AN-H

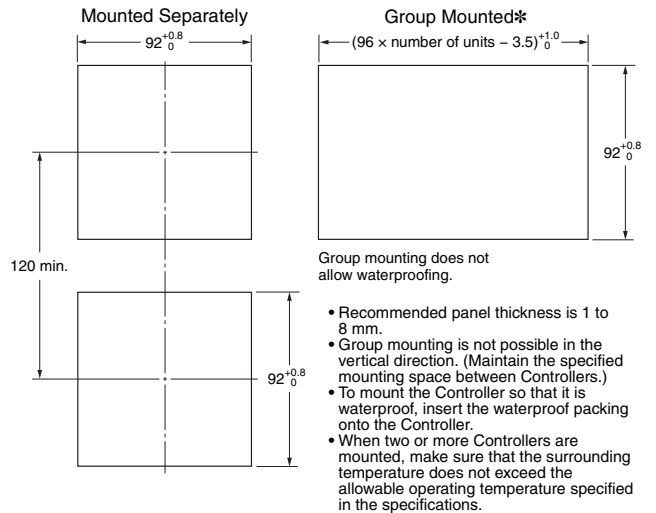
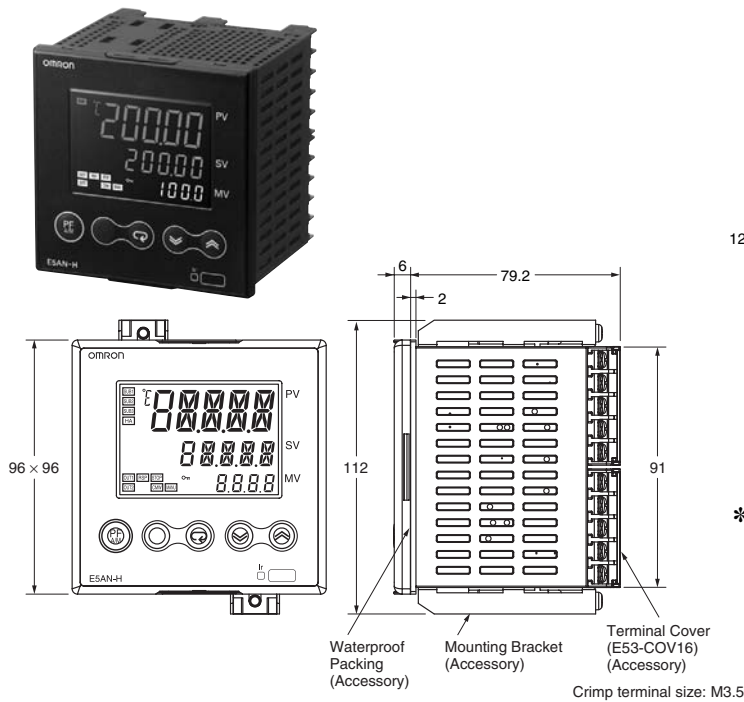

* Group mounting is not possible if an SSR output is used for control output 1 or 2 and the E53-C3N or E53-C3DN Output Unit is used. For these combinations, maintain the following mounting space between Controllers.

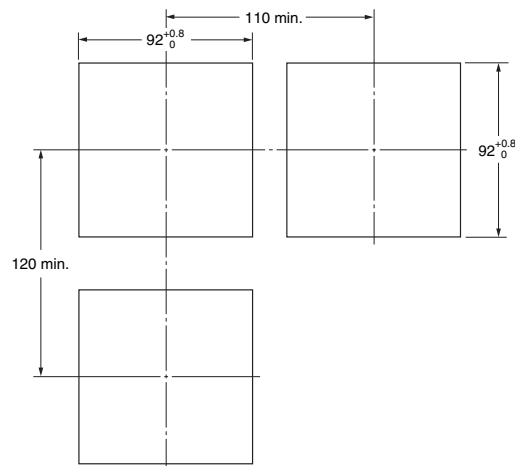

E5CN (96 x 96 mm)
E5EN-U (48 x 48 mm)

E5AN-H (48 x 48 mm)

E5AN-H (48 x 48 mm)

E5AN-H (96 x 96 mm)
E5EN-H (48 x 96 mm)

Operation

Safety Precautions

E5EN-H

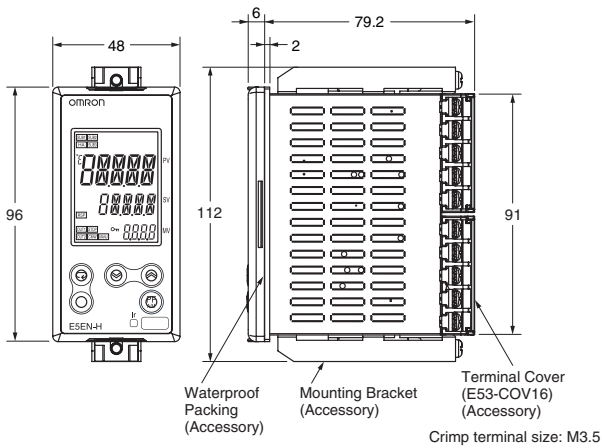

Mounted Separately

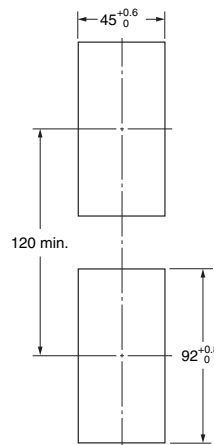

Group Mounted*

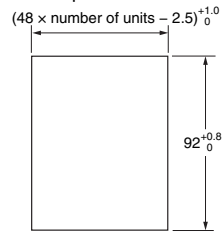

Group mounting does not allow waterproofing.

- Recommended panel thickness is 1 to 8 mm.
- Group mounting is not possible in the vertical direction. (Maintain the specified mounting space between Controllers.)
- When two or more Controllers are mounted, make sure that the surrounding temperature does not exceed the allowable operating temperature specified in the specifications.

* Group mounting is not possible if an SSR output is used for control output 1 or 2 and the E53-C3N or E53-C3DN Output Unit is used. For these combinations, maintain the following mounting space between Controllers.

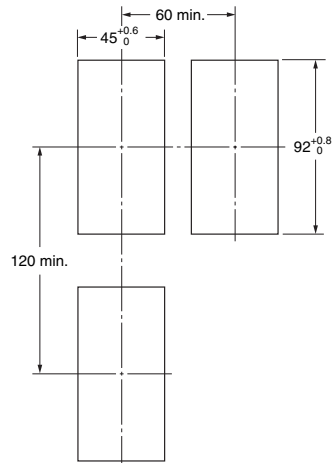

E5CN
E5CN-U (48 x 48 mm)

E5AN (96 x 96 mm)
E5EN (48 x 96 mm)

E5CN-H (48 x 48 mm)

E5AN-H (96 x 96 mm)
E5EN-H (48 x 96 mm)

Operation

Safety Precautions

E5AN-H/E5EN-H

Accessories (Order Separately)

E5CN
E5CN-U (48 x 48 mm)

USB-Infrared Conversion Cable

E58-CIFIR

USB-Infrared Conversion Cable

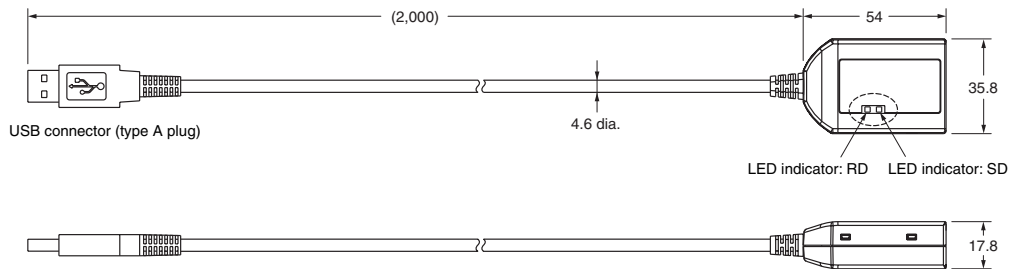

E5AN (96 x 96 mm)
E5EN (48 x 96 mm)

Mounting Adapter

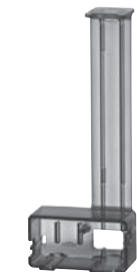

With Mounting Adapter Connected

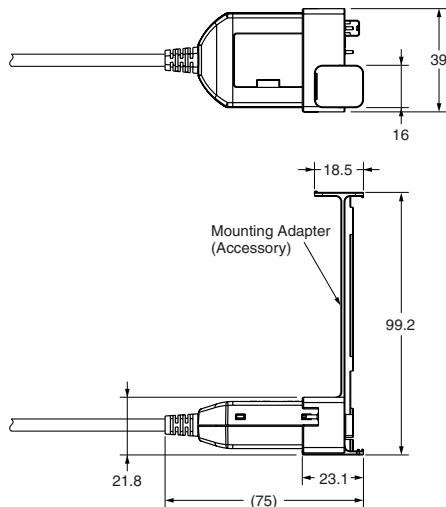

E5CN-H (48 x 48 mm)

E5AN-H (96 x 96 mm)
E5EN-H (48 x 96 mm)

USB-Serial Conversion Cable

E58-CIFQ1

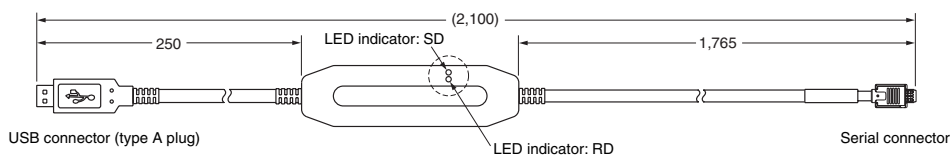
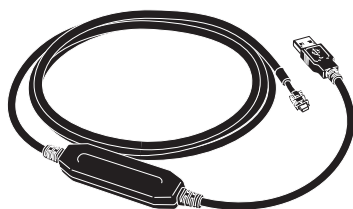

Operation

Terminal Covers

E53-COV16 (Six Covers provided.)

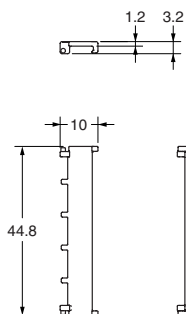

Safety Precautions

Waterproof Packing

Y92S-P4 (for DIN 96 × 96)

Y92S-P5 (for DIN 48 × 96)

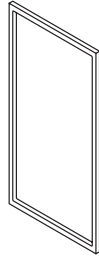
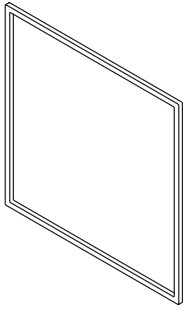

Order the Waterproof Packing separately if it becomes lost or damaged.

The Waterproof Packing can be used to achieve an IP66 degree of protection.

(Deterioration, shrinking, or hardening of the waterproof packing may occur depending on the operating environment. Therefore, periodic replacement is recommended to ensure the level of waterproofing specified in IP66. The time for periodic replacement depends on the operating environment. Be sure to confirm this point at your site. Consider one year a rough standard. OMRON shall not be liable for the level of water resistance if the customer does not perform periodic replacement.)

The Waterproof Packing does not need to be attached if a waterproof structure is not required.

E5CN
E5CN-U (48 x 48 mm)

E5AN (96 x 96 mm)
E5EN (48 x 96 mm)

E5CN-H (48 x 48 mm)

E5AN-H (96 x 96 mm)
E5EN-H (48 x 96 mm)

Operation

Safety Precautions

Current Transformers

E54-CT1

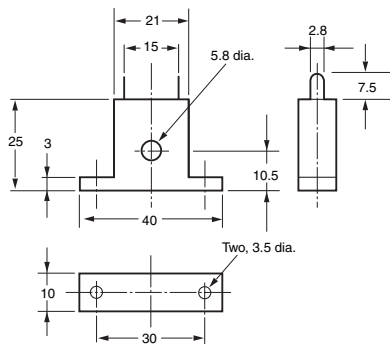
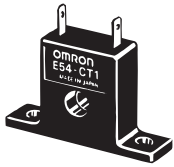

E54-CT1

Thru-current (I_o) vs. Output Voltage (E_o) (Reference Values)

Maximum continuous heater current: 50 A (50/60 Hz)

Number of windings: 400±2

Winding resistance: 18±2 Ω

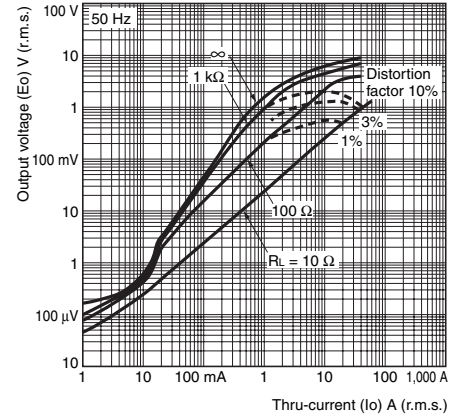

E54-CT3

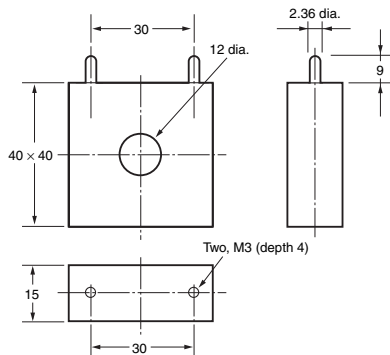

E54-CT3

Thru-current (I_o) vs. Output Voltage (E_o) (Reference Values)

Maximum continuous heater current: 120 A (50/60 Hz)

(Maximum continuous heater current for an OMRON Temperature Controller is 50 A.)

Number of windings: 400±2

Winding resistance: 8±0.8 Ω

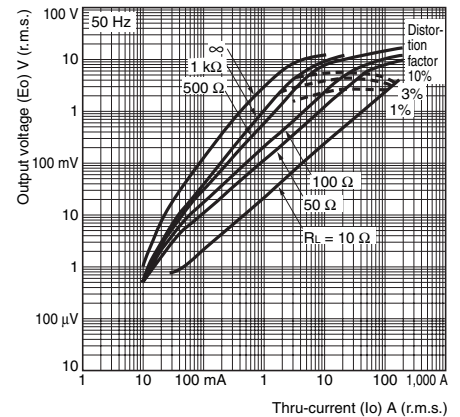

E54-CT3 Accessory

• Armature

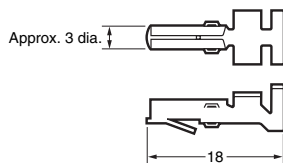

• Plug

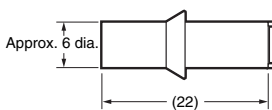

Connection Example

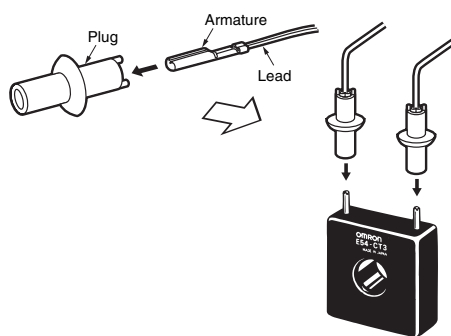

Operation

Setting Levels Diagram

This diagram shows all of the setting levels. To move to the advanced function setting level and calibration level, you must enter passwords. Some parameters are not displayed depending on the protect level setting and the conditions of use. Control stops when you move from the operation level to the initial setting level.

Basic Type

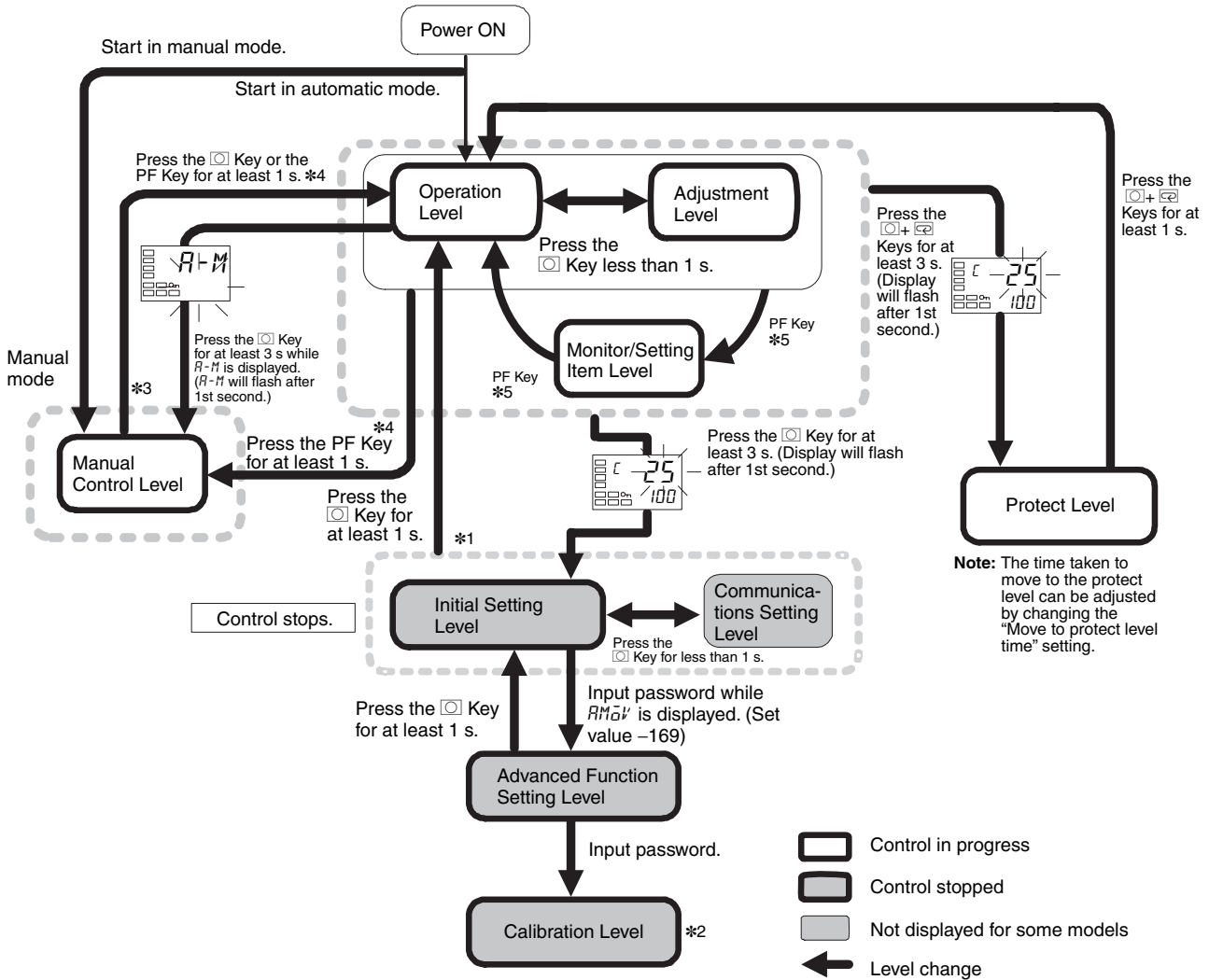

- *1. You can return to the operation level by executing a software reset.
- *2. It is not possible to move to other levels from the calibration level by operating the keys on the front panel. It can be done only by first turning OFF the power.
- *3. From the manual control level, key operations can be used to move to the operation level only.
- *4. When the PF Setting parameter is set to A-M for a Controller with a PF Key (E5AN/E5EN).
- *5. When the PF Setting parameter is set to PFDP for a Controller with a PF Key (E5AN/E5EN)

Error Displays (Troubleshooting)

When an error occurs, the No.1 display shows the error code. Take necessary measure according to the error code, referring the table below.

No.1 display	Meaning	Action	Status at error	
			Control output	Alarm output
S.ERR (S. Err)	Input error *	Check the wiring of inputs for miswiring, disconnections, and short-circuits and check the input type.	OFF	Operates as above the upper limit.
E333 (E333)	A/D converter error	Turn the power OFF then back ON again. If the display remains the same, the controller must be repaired. If the display is restored to normal, then a probable cause can be external noise affecting the control system. Check for external noise.	OFF	OFF
E111 (E111)	Memory error	Turn the power OFF then back ON again. If the display remains the same, the controller must be repaired. If the display is restored to normal, then a probable cause can be external noise affecting the control system. Check for external noise.	OFF	OFF

Note: If the input value exceeds the display limit (-1999 to 9999), though it is within the control range, EEEEE will be displayed under -1999 and EEEEE above 9999. Under these conditions, control output and alarm output will operate normally.

For details on the control range, refer to the E5CN/E5AN/E5EN Digital Temperature Controllers User's Manual Basic Type (Cat. No. H156).

* These errors are displayed only when the PV/SP is displayed. Errors are not displayed for other displays.

Operation Safety Precautions

E5CN (48 x 48 mm) E5CN-U (48 x 48 mm) E5AN (96 x 96 mm) E5EN (48 x 96 mm) E5CN-H (48 x 48 mm) E5AN-H (96 x 96 mm) E5EN-H (48 x 96 mm)

Advanced Type

E5CN
E5CN-U (48 x 48 mm)

E5AN (96 x 96 mm)
E5EN (48 x 96 mm)

E5CN-H (48 x 48 mm)

E5AN-H (96 x 96 mm)
E5EN-H (48 x 96 mm)

Operation

Safety Precautions

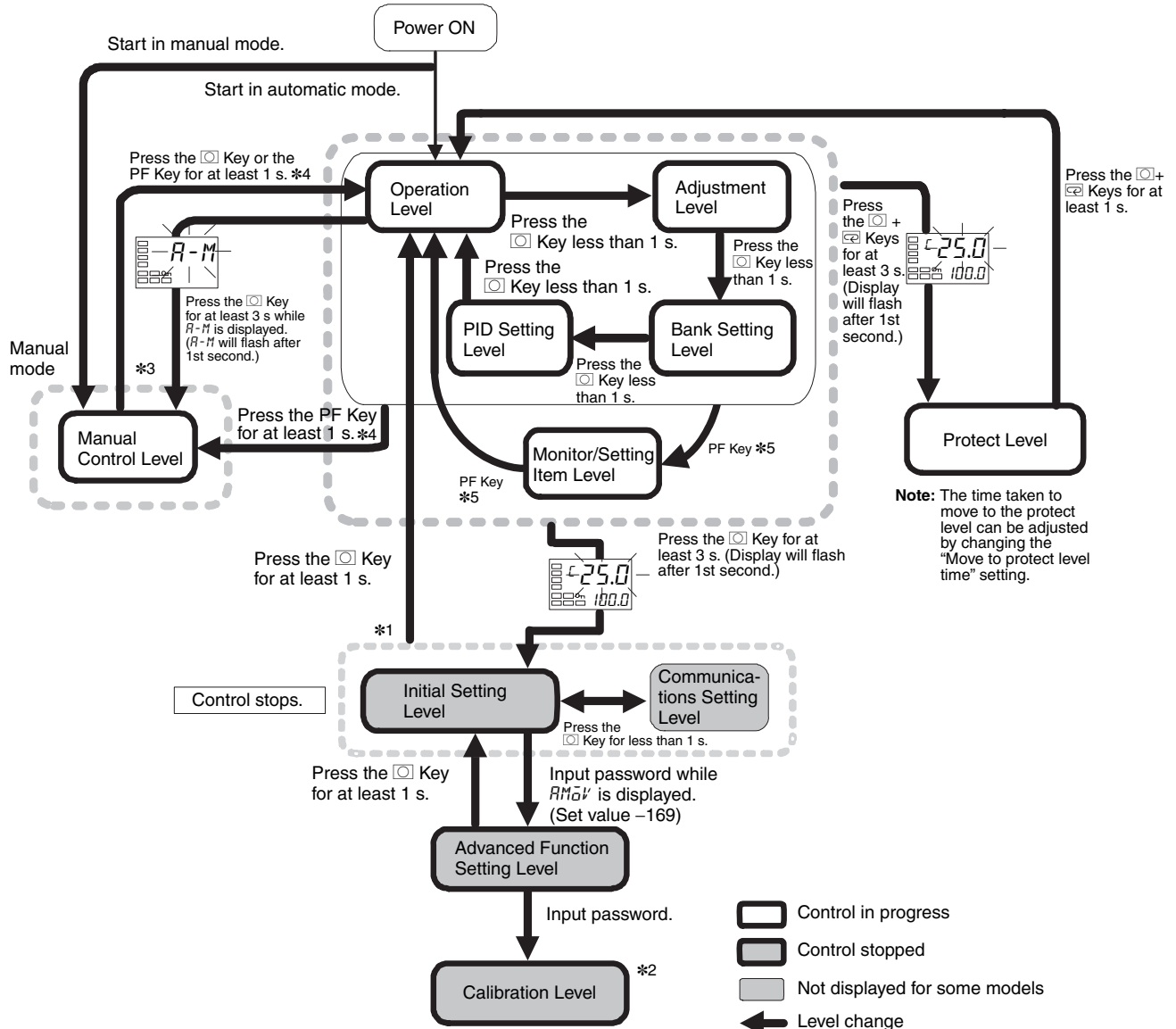

- *1. You can return to the operation level by executing a software reset.
- *2. It is not possible to move to other levels from the calibration level by operating the keys on the front panel. It can be done only by first turning OFF the power.
- *3. From the manual control level, key operations can be used to move to the operation level only.
- *4. When the PF Setting parameter is set to A-M for a Controller with a PF Key (E5AN-H/E5EN-H).
- *5. When the PF Setting parameter is set to PFDP for a Controller with a PF Key (E5AN-H/E5EN-H)

Error Displays (Troubleshooting)

When an error occurs, the No.1 display shows the error code. Take necessary measure according to the error code, referring the table below.

No.1 display	Meaning	Action	Status at error	
			Control output	Alarm output
$\overline{5ERR}$ (S. Err)	Input error *	Check the wiring of inputs for miswiring, disconnections, and short-circuits and check the input type.	OFF	Operates as above the upper limit.
$\overline{E333}$ (E333)	A/D converter error	Turn the power OFF then back ON again. If the display remains the same, the controller must be repaired. If the display is restored to normal, then a probable cause can be external noise affecting the control system. Check for external noise.	OFF	OFF
$\overline{E111}$ (E111)	Memory error	Turn the power OFF then back ON again. If the display remains the same, the controller must be repaired. If the display is restored to normal, then a probable cause can be external noise affecting the control system. Check for external noise.	OFF	OFF

Note: If the input value exceeds the display limit (-19999 to 32400), though it is within the control range, \overline{EEEE} will be displayed under -19999 and $\overline{3333}$ above 32400. Under these conditions, control output and alarm output will operate normally.

For details on the control range, refer to the *E5CN-H/E5AN-H/E5EN-H Digital Controllers User's Manual Advanced Type* (Cat. No. H157).

* These errors are displayed only when the PV/SP is displayed. Errors are not displayed for other displays.

Parameters

Basic Type

Some parameters are not displayed depending on the model of the Controller and parameter settings. For details, refer to the *E5CN/E5AN/E5EN Digital Temperature Controllers User's Manual Basic Type* (Cat. No. H156).

E5CN
E5CN-U (48 x 48 mm)

E5AN (96 x 96 mm)
E5EN (48 x 96 mm)

E5CN-H (48 x 48 mm)

E5AN-H (96 x 96 mm)
E5EN-H (48 x 96 mm)

Operation

Safety Precautions

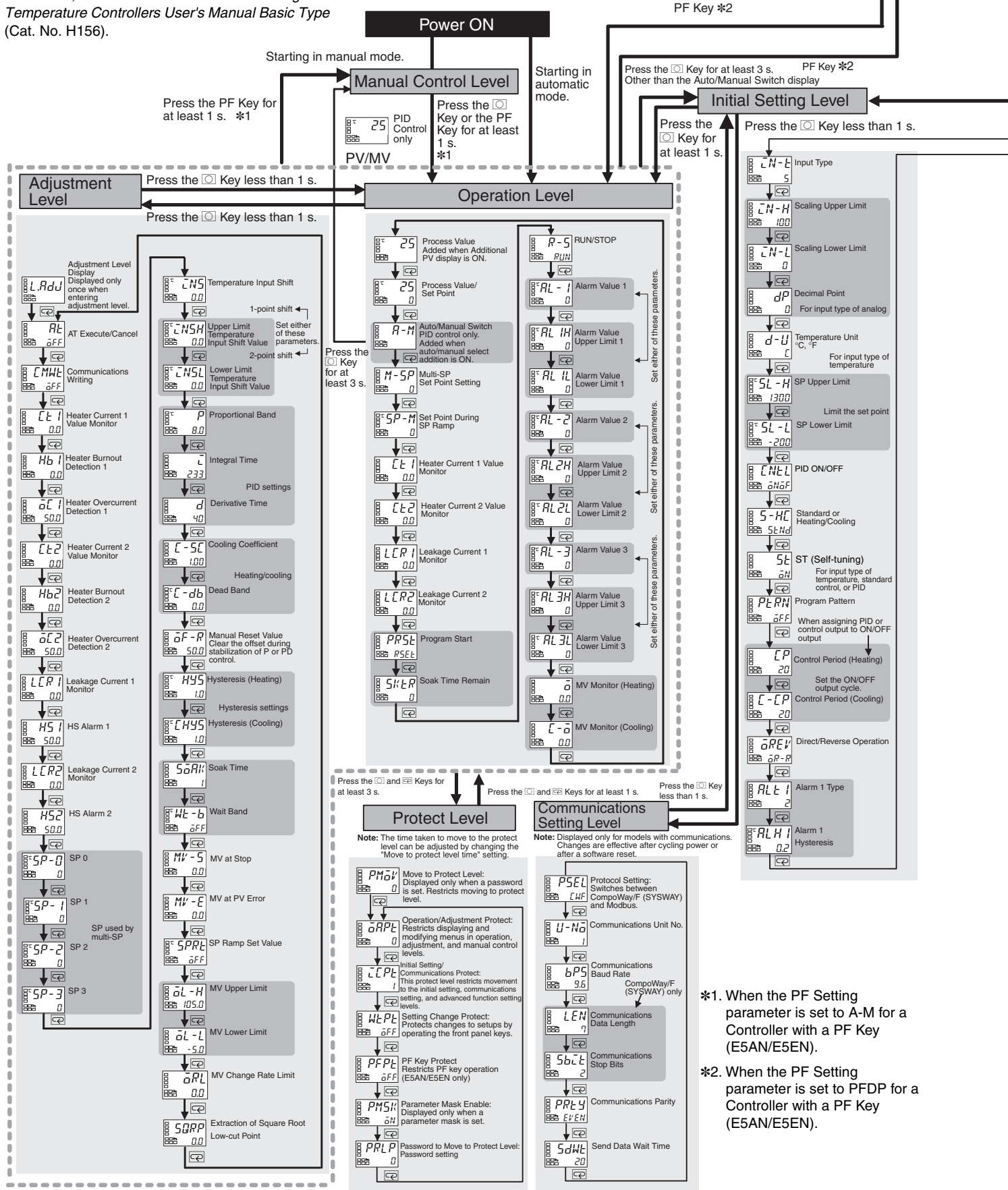

- *1. When the PF Setting parameter is set to A-M for a Controller with a PF Key (E5AN/E5EN).
- *2. When the PF Setting parameter is set to PFDP for a Controller with a PF Key (E5AN/E5EN).

Monitor/Setting Item Level (E5AN/E5EN only)



Note: The monitor/setting items to be displayed is set in the Monitor/Setting Item 1 to 5 parameters (advanced function setting level).

Press the Key for at least 1 s.

Advanced Function Setting Level

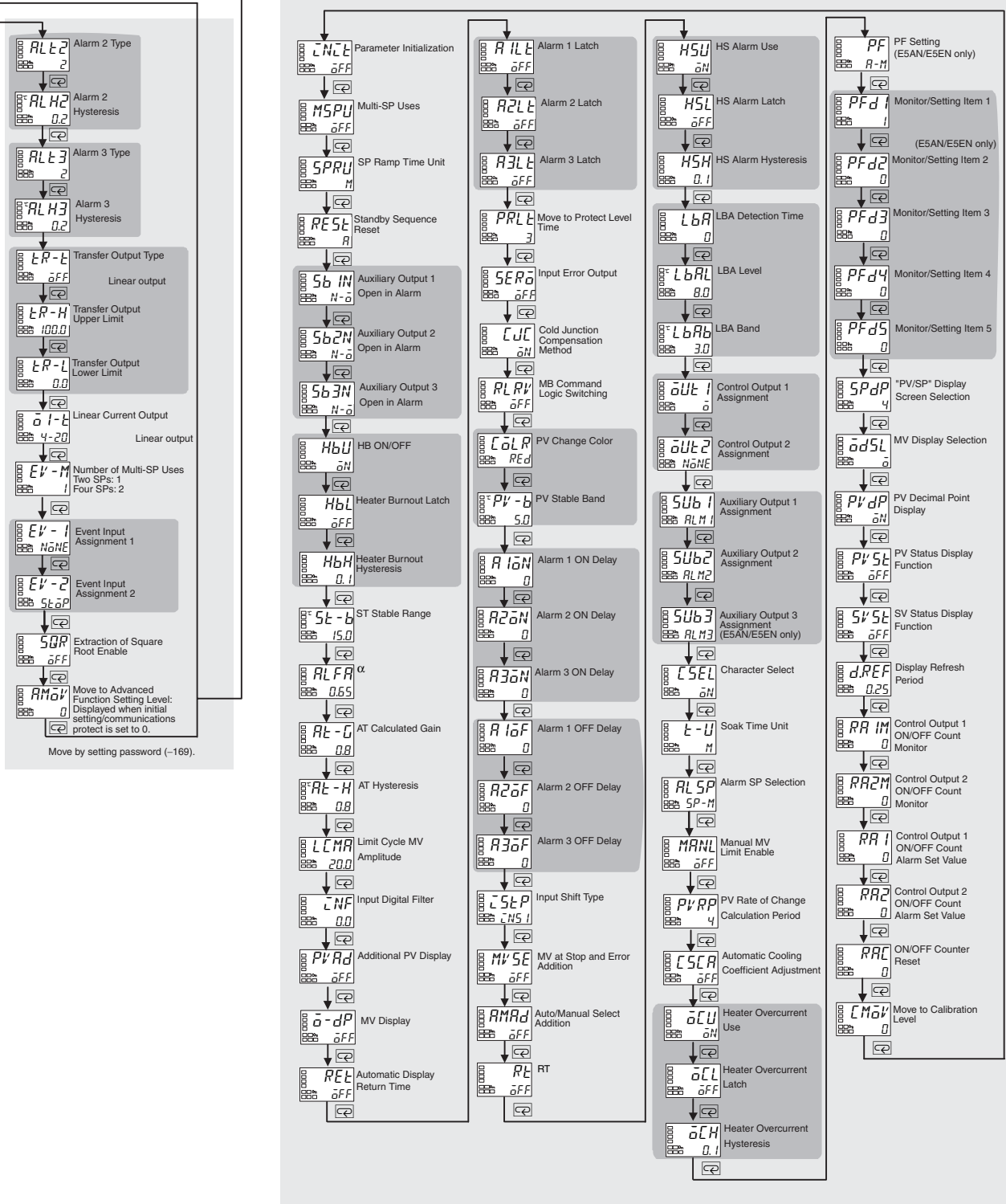

E5CN
E5CN-U (48 x 48 mm)

E5AN (96 x 96 mm)
E5EN (48 x 96 mm)

E5CN-H (48 x 48 mm)

E5AN-H (96 x 96 mm)
E5EN-H (48 x 96 mm)

Operation

Safety Precautions

Advanced Type

Some parameters are not displayed depending on the model of the Controller and parameter settings.

For details, refer to the *E5CN-H/E5AN-H/E5EN-H Digital Controllers User's Manual Advanced Type* (Cat. No. H157).

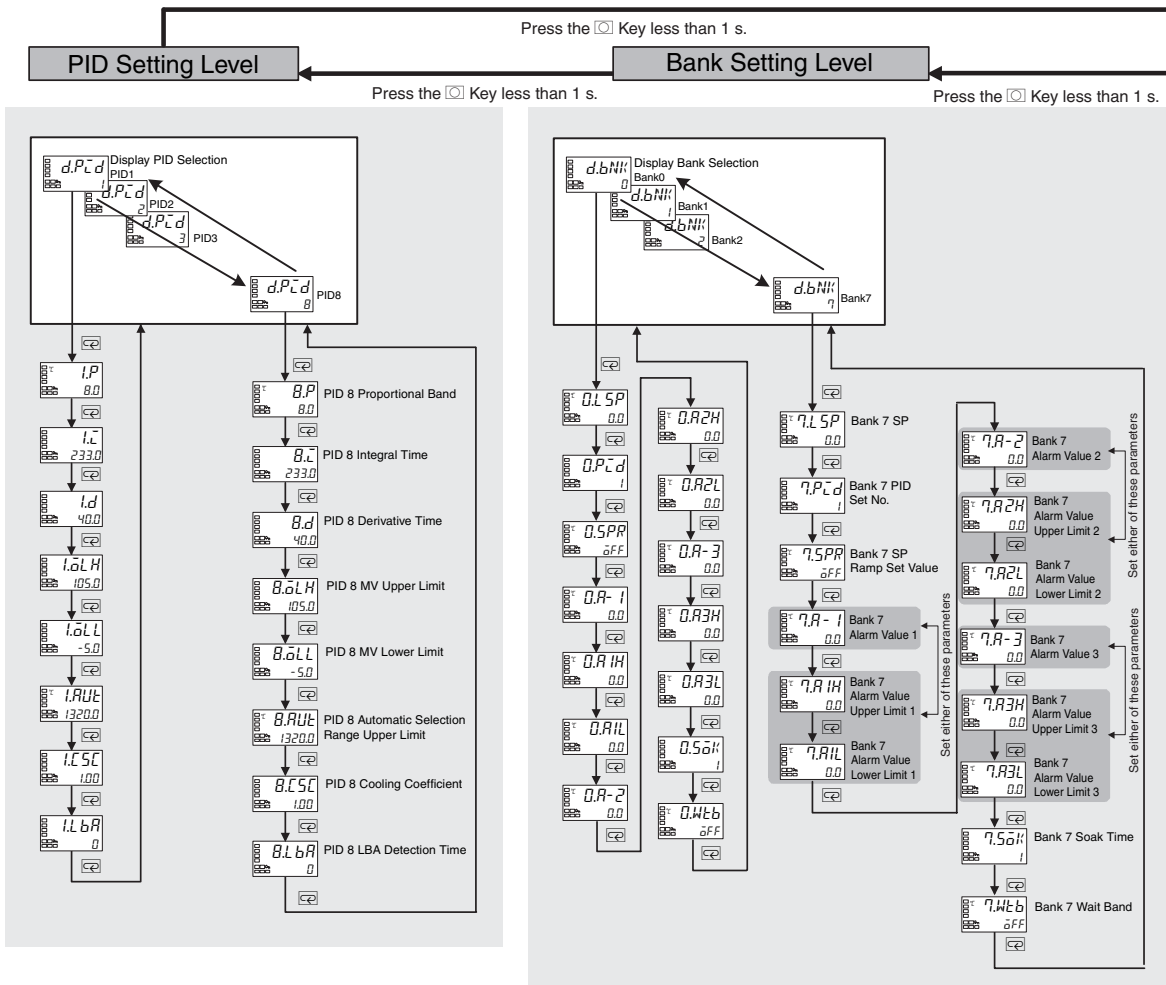
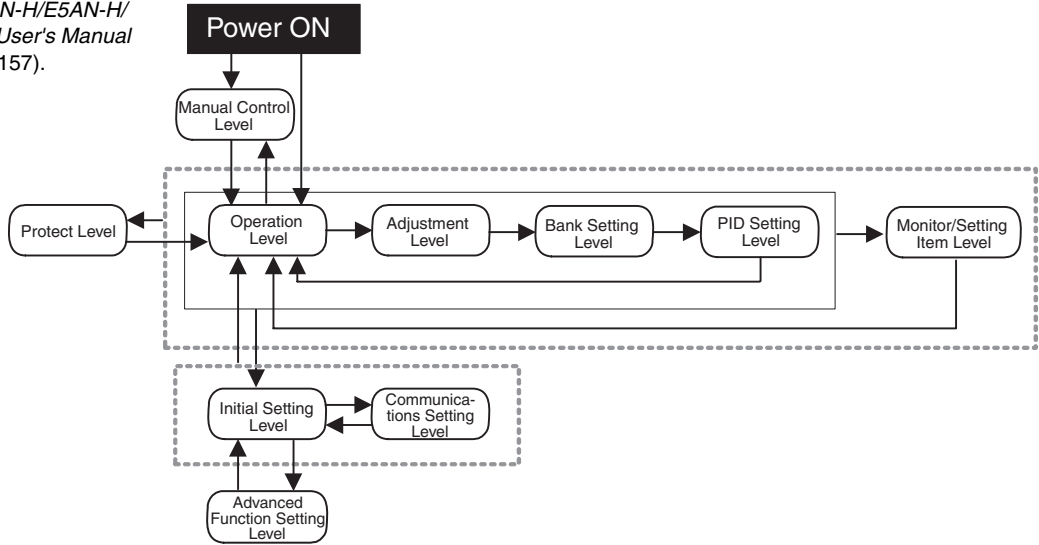

E5CN (48 x 48 mm)
E5CN-U (48 x 48 mm)

E5AN (96 x 96 mm)
E5EN (48 x 96 mm)

E5CN-H (48 x 48 mm)

E5AN-H (96 x 96 mm)
E5EN-H (48 x 96 mm)

Operation

Safety Precautions

E5CN
E5CN-U (48 x 48 mm)

E5AN (96 x 96 mm)
E5EN (48 x 96 mm)

E5CN-H (48 x 48 mm)

E5AN-H (96 x 96 mm)
E5EN-H (48 x 96 mm)

Operation

Safety Precautions

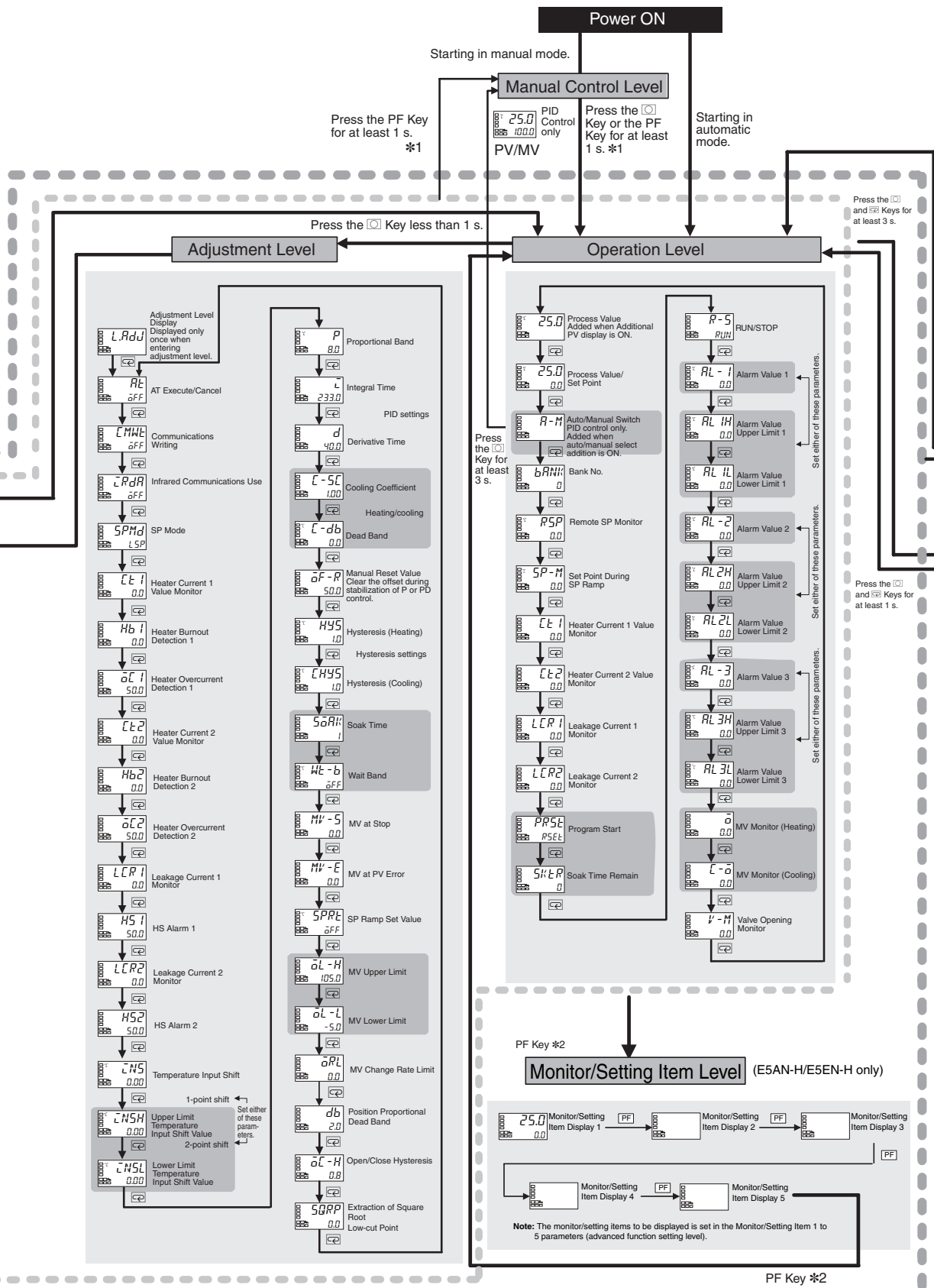

*1. When the PF Setting parameter is set to A-M for a Controller with a PF Key (E5AN-H/E5EN-H).
*2. When the PF Setting parameter is set to PFDP for a Controller with a PF Key (E5AN-H/E5EN-H).

E5CN
E5CN-U (48 x 48 mm)

E5AN (96 x 96 mm)
E5EN (48 x 96 mm)

E5CN-H (48 x 48 mm)

E5AN-H (96 x 96 mm)
E5EN-H (48 x 96 mm)

Operation

Safety Precautions

Press the Key for at least 1 s.

Press the Key for at least 3 s.
Other than the Auto/Manual Switch display

Press the Key less than 1 s.

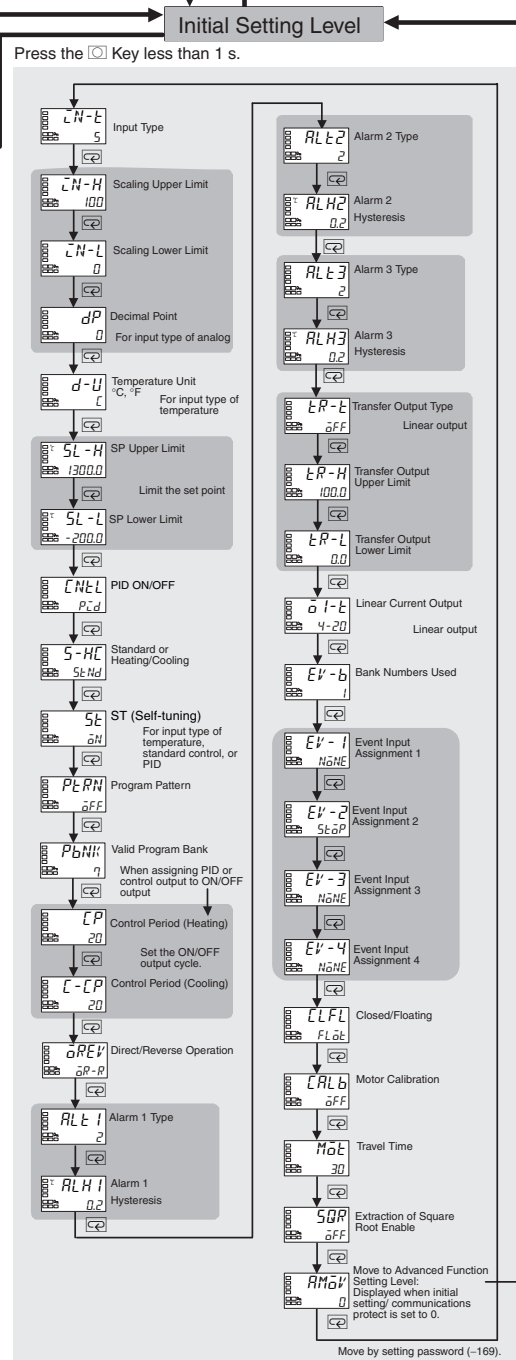
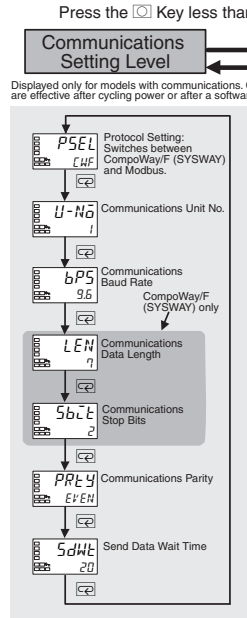
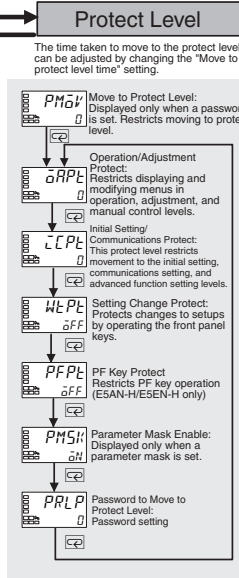

Move by setting password (-169).

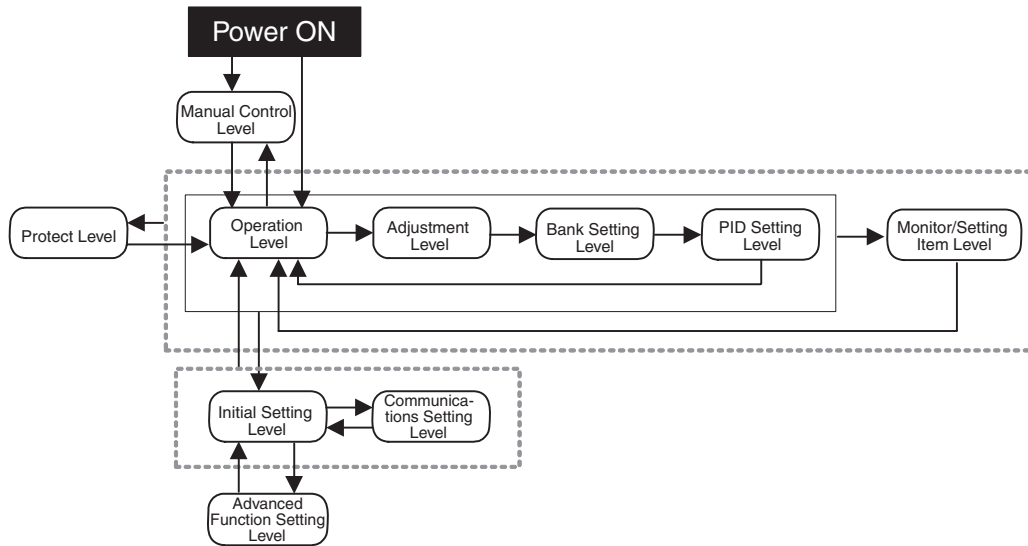

Press the Key for at least 1 s.

Advanced Function Setting Level

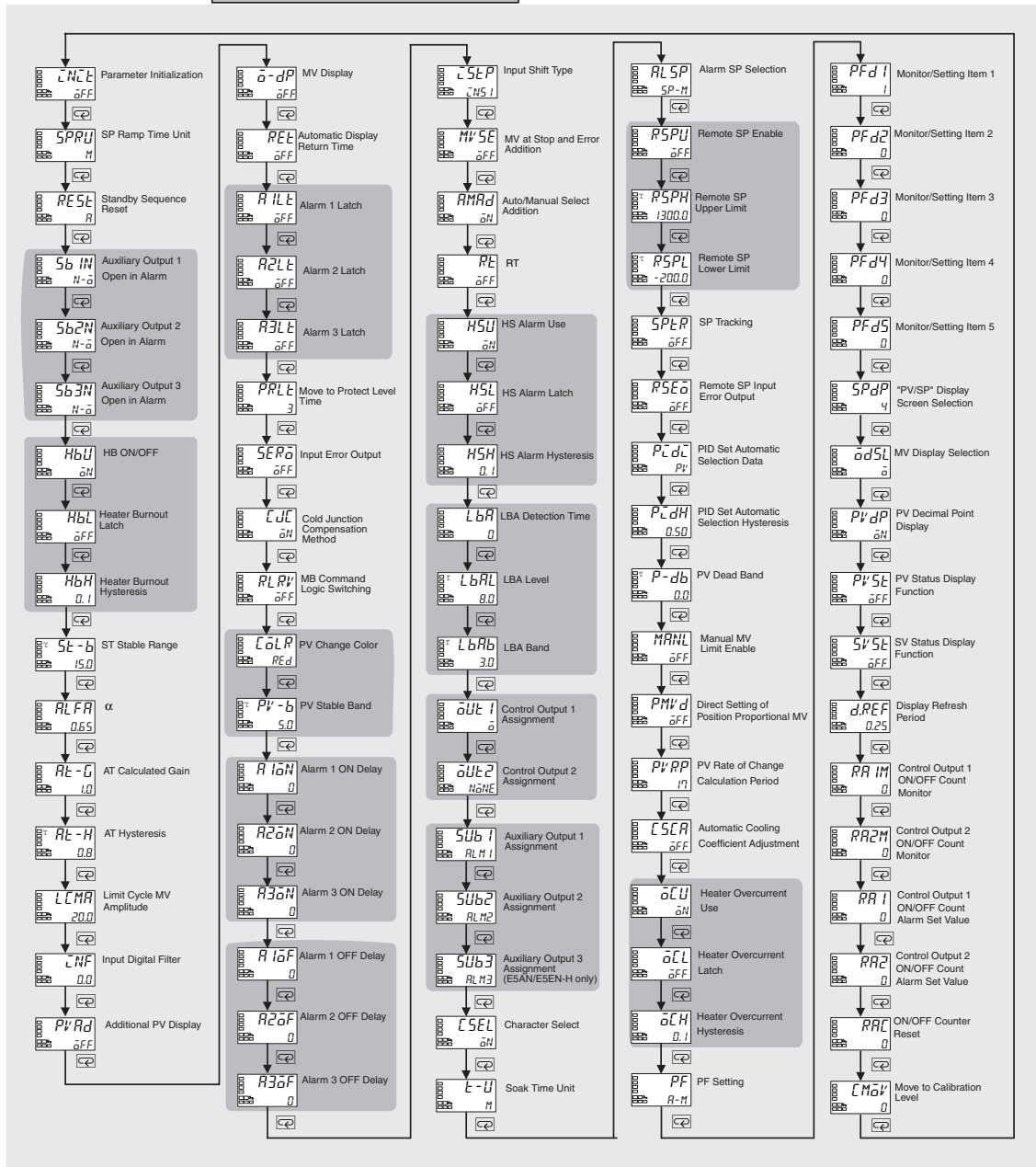

E5CN
E5CN-U (48 x 48 mm)

E5AN (96 x 96 mm)
E5EN (48 x 96 mm)

E5CN-H (48 x 48 mm)

E5AN-H (96 x 96 mm)
E5EN-H (48 x 96 mm)

Operation

Safety Precautions

Safety Precautions

E5CN
E5CN-U (48 x 48 mm)

E5AN (96 x 96 mm)
E5EN (48 x 96 mm)

E5CN-H (48 x 48 mm)

E5AN-H (96 x 96 mm)
E5EN-H (48 x 96 mm)

Operation

Safety Precautions

 **CAUTION**

Do not touch the terminals while power is being supplied. Doing so may occasionally result in minor injury due to electric shock. 

Do not allow pieces of metal, wire clippings, or fine metallic shavings or filings from installation to enter the product. Doing so may occasionally result in electric shock, fire, or malfunction. 

Do not use the product where subject to flammable or explosive gas. Otherwise, minor injury from explosion may occasionally occur. 

Do not leave the cable for the Support Software connected to the product. Malfunction may occur due to noise in the cable. 

Do not use the Temperature Controller or Conversion Cable if it is damaged. Doing so may occasionally result in minor electric shock or fire. 

Never disassemble, modify, or repair the product or touch any of the internal parts. Minor electric shock, fire, or malfunction may occasionally occur. 

CAUTION - Risk of Fire and Electric Shock

a) This product is UL listed as Open Type Process Control Equipment. It must be mounted in an enclosure that does not allow fire to escape externally. 

b) More than one disconnect switch may be required to de-energize the equipment before servicing the product.

c) Signal inputs are SELV, limited energy. *1

d) Caution: To reduce the risk of fire or electric shock, do not interconnect the outputs of different Class 2 circuits. *2

If the output relays are used past their life expectancy, contact fusing or burning may occasionally occur. Always consider the application conditions and use the output relays within their rated load and electrical life expectancy. The life expectancy of output relays varies considerably with the output load and switching conditions. 

Tighten the terminal screws to between 0.74 and 0.90 N-m. *3 Loose screws may occasionally result in fire. 

Set the parameters of the product so that they are suitable for the system being controlled. If they are not suitable, unexpected operation may occasionally result in property damage or accidents. 

A malfunction in the product may occasionally make control operations impossible or prevent alarm outputs, resulting in property damage. To maintain safety in the event of malfunction of the product, take appropriate safety measures, such as installing a monitoring device on a separate line. 

A semiconductor is used in the output section of long-life relays. If excessive noise or surge is impressed on the output terminals, a short-circuit failure is likely to occur. If the output remains shorted, fire will occur due to overheating of the heater or other cause. Take measures in the overall system to prevent excessive temperature increase and to prevent fire from spreading. 

Do not allow pieces of metal or wire cuttings to get inside the cable connector for the Support Software. Failure to do so may occasionally result in minor electric shock, fire, or damage to equipment. 

Do not allow dust and dirt to collect between the pins in the connector on the Conversion Cable. Failure to do so may occasionally result in fire. 

When inserting the body of the Temperature Controller into the case, confirm that the hooks on the top and bottom are securely engaged with the case. If the body of the Temperature Controller is not inserted properly, faulty contact in the terminal section or reduced water resistance may occasionally result in fire or malfunction. 

When connecting the Control Output Unit to the socket, press it in until there is no gap between the Control Output Unit and the socket. Otherwise contact faults in the connector pins may occasionally result in fire or malfunction. 

- *1. An SELV circuit is one separated from the power supply with double insulation or reinforced insulation, that does not exceed 30 V r.m.s. and 42.4 V peak or 60 VDC.
- *2. A class 2 power supply is one tested and certified by UL as having the current and voltage of the secondary output restricted to specific levels.
- *3. The tightening torque for E5CN-U is 0.5 N-m.

Precautions for Safe Use

Be sure to observe the following precautions to prevent malfunction or adverse affects on the performance or functionality of the product. Not doing so may occasionally result in faulty operation.

1. This product is specifically designed for indoor use only. Do not use this product in the following places:
 - Places directly subject to heat radiated from heating equipment.
 - Places subject to splashing liquid or oil atmosphere.
 - Places subject to direct sunlight.
 - Places subject to dust or corrosive gas (in particular, sulfide gas and ammonia gas).
 - Places subject to intense temperature change.
 - Places subject to icing and condensation.
 - Places subject to vibration and large shocks.
2. Use and store the product within the rated ambient temperature and humidity. Gang-mounting two or more Temperature Controllers, or mounting Temperature Controllers above each other may cause heat to build up inside the Temperature Controllers, which will shorten their service life. In such a case, use forced cooling by fans or other means of air ventilation to cool down the Temperature Controllers.
3. To allow heat to escape, do not block the area around the product. Do not block the ventilation holes on the product.
4. Be sure to wire properly with correct polarity of terminals.
5. Use the specified size (M3.5, width 7.2 mm or less) crimped terminals for wiring. To connect bare wires to the terminal block, use stranded or solid copper wires with a gage of AWG24 to AWG14 (equal to a cross-sectional area of 0.205 to 2.081 mm²). (The stripping length is 5 to 6 mm.) Up to two wires of the same size and type or two crimp terminals can be inserted into a single terminal.
6. Do not wire the terminals that are not used.
7. To avoid inductive noise, keep the wiring for the product's terminal block away from power cables carry high voltages or large currents. Also, do not wire power lines together with or parallel to product wiring. Using shielded cables and using separate conduits or ducts is recommended. Attach a surge suppressor or noise filter to peripheral devices that generate noise (in particular, motors, transformers, solenoids, magnetic coils, or other equipment that have an inductance component). When a noise filter is used at the power supply, first check the voltage or current, and attach the noise filter as close as possible to the product. Allow as much space as possible between the product and devices that generate powerful high frequencies (high-frequency welders, high-frequency sewing machines, etc.) or surge.
8. Use this product within the rated load and power supply.
9. Make sure that the rated voltage is attained within two seconds of turning ON the power using a switch or relay contact. If the voltage is applied gradually, the power may not be reset or output malfunctions may occur.
10. Make sure that the Temperature Controller has 30 minutes or more to warm up after turning ON the power before starting actual control operations to ensure the correct temperature display.

11. When executing self-tuning, turn ON power to the load (e.g., heater) at the same time as or before supplying power to the product. If power is turned ON to the product before turning ON power to the load, self-tuning will not be performed properly and optimum control will not be achieved.
12. A switch or circuit breaker must be provided close to the product. The switch or circuit breaker must be within easy reach of the operator, and must be marked as a disconnecting means for this unit.
13. Always turn OFF the power supply before pulling out the interior of the product, and never touch nor apply shock to the terminals or electronic components. When inserting the interior of the product, do not allow the electronic components to touch the case.
14. Do not use paint thinner or similar chemical to clean with. Use standard grade alcohol.
15. Design the system (e.g., control panel) considering the 2 seconds of delay that the product's output to be set after power ON.
16. The output may turn OFF when shifting to certain levels. Take this into consideration when performing control.
17. The number of EEPROM write operations is limited. Therefore, use RAM write mode when frequently overwriting data during communications or other operations.
18. Always touch a grounded piece of metal before touching the Temperature Controller to discharge static electricity from your body.
19. Do not remove the terminal block. Doing so may result in failure or malfunction.
20. Control outputs (for driving SSR) that are voltage outputs are not isolated from the internal circuits. When using a grounded thermocouple, do not connect any of the control output terminals to ground. (Doing so may result in an unwanted circuit path, causing error in the measured temperature.)
21. When replacing the body of the Temperature Controller, check the condition of the terminals. If corroded terminals are used, contact failure in the terminals may cause the temperature inside the Temperature Controller to increase, possibly resulting in fire. If the terminals are corroded, replace the case as well.
22. Use suitable tools when taking the Temperature Controller apart for disposal. Sharp parts inside the Temperature Controller may cause injury.
23. Before connecting an Output Unit, confirm the specifications and thoroughly read relevant information in the datasheet and manual for the Temperature Controller.
24. Check the orientation of the connectors on the Conversion Cable before connecting the Conversion Cable. Do not force a connector if it does not connect smoothly. Using excessive force may damage the connector.
25. Do not place heavy object on the Conversion Cable, bend the cable past its natural bending radius, or pull on the cable with undue force.
26. Do not connect or disconnect the Conversion Cable while communications are in progress. Product faults or malfunction may occur.
27. Make sure that the Conversion Cable's metal components are not touching the external power terminals.
28. Do not touch the connectors on the Conversion Cable with wet hands. Electrical shock may result.
29. Before using infrared communications, correctly attach the enclosed Mounting Adapter to the cable for the Support Software. When connecting the infrared port on the cable to the Support Software into the Adapter, insert the connector to the specified line. Communications may not be possible if the connector is not connected properly.

Precautions for Correct Use

Service Life

1. Use the product within the following temperature and humidity ranges:
 Temperature: -10 to 55°C (with no icing or condensation)
 Humidity: 25% to 85%
 If the product is installed inside a control board, the ambient temperature must be kept to under 55°C, including the temperature around the product.
2. The service life of electronic devices like Temperature Controllers is determined not only by the number of times the relay is switched but also by the service life of internal electronic components. Component service life is affected by the ambient temperature: the higher the temperature, the shorter the service life and, the lower

the temperature, the longer the service life. Therefore, the service life can be extended by lowering the temperature of the Temperature Controller.

3. When two or more Temperature Controllers are mounted horizontally close to each other or vertically next to one another, the internal temperature will increase due to heat radiated by the Temperature Controllers and the service life will decrease. In such a case, use forced cooling by fans or other means of air ventilation to cool down the Temperature Controllers. When providing forced cooling, however, be careful not to cool down the terminals sections alone to avoid measurement errors.

Measurement Accuracy

1. When extending or connecting the thermocouple lead wire, be sure to use compensating wires that match the thermocouple types.
2. When extending or connecting the lead wire of the platinum resistance thermometer, be sure to use wires that have low resistance and keep the resistance of the three lead wires the same.
3. Mount the product so that it is horizontally level.
4. If the measurement accuracy is low, check to see if input shift has been set correctly.

Waterproofing

The degree of protection is as shown below. Sections without any specification on their degree of protection or those with IP□□ are not waterproof.

Front panel: IP66

Rear case: IP20, Terminal section: IP00

(E5CN-U: Front panel: IP50, rear case: IP20, terminals: IP00)

Operating Precautions

1. It takes approximately two seconds for the outputs to turn ON from after the power supply is turned ON. Due consideration must be given to this time when incorporating Temperature Controllers in a sequence circuit.
2. When using self-tuning, turn ON power for the load (e.g., heater) at the same time as or before supplying power to the Temperature Controller. If power is turned ON for the Temperature Controller before turning ON power for the load, self-tuning will not be performed properly and optimum control will not be achieved.
3. When starting operation after the Temperature Controller has warmed up, turn OFF the power and then turn it ON again at the same time as turning ON power for the load. (Instead of turning the Temperature Controller OFF and ON again, switching from STOP mode to RUN mode can also be used.)
4. Avoid using the Controller in places near a radio, television set, or wireless installing. These devices can cause radio disturbances which adversely affect the performance of the Controller.

Others

1. The disk that is included with the Conversion Cable is designed for a computer CD-ROM driver. Never attempt to play the disk in a general-purpose audio player.
2. Do not connect or disconnect the Conversion Cable connector repeatedly over a short period of time. The computer may malfunction.
3. After connecting the Conversion Cable to the computer, check the COM port number before starting communications. The computer requires time to recognize the cable connection. This delay does not indicate failure.
4. Do not connect the Conversion Cable through a USB hub. Doing so may damage the Conversion Cable.
5. Do not use an extension cable to extend the Conversion Cable length when connecting to the computer. Doing so may damage the Conversion Cable.
6. The E5AN-H/E5EN-H use the same port for communications through the infrared port and the Support Software port. Do not attempt to use communications through the Support Software port when the infrared port is being used.

E5CN
E5CN-U (48 x 48 mm)

E5AN (96 x 96 mm)
E5EN (48 x 96 mm)

E5CN-H (48 x 48 mm)

E5AN-H (96 x 96 mm)
E5EN-H (48 x 96 mm)

Operation

Safety Precautions

Mounting

Mounting to a Panel

For waterproof mounting, waterproof packing must be installed on the Controller. Waterproofing is not possible when group mounting several Controllers. Waterproof packing is not necessary when there is no need for the waterproofing function.

E5CN

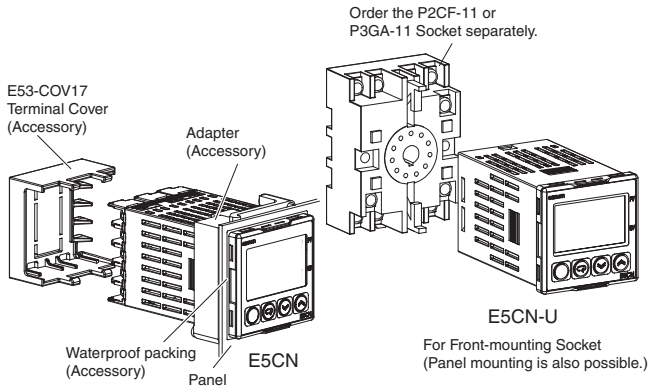

1. The Panel Mounting Adapter is also included with the E5CN-U. There is no waterproof packing included with the E5CN-U.
2. Insert the E5CN/E5CN-U into the mounting hole in the panel.
3. Push the adapter from the terminals up to the panel, and temporarily fasten the E5CN/E5CN-U.
4. Tighten the two fastening screws on the adapter. Alternately tighten the two screws little by little to maintain a balance. Tighten the screws to a torque of 0.29 to 0.39 N·m.

E5EN/E5AN

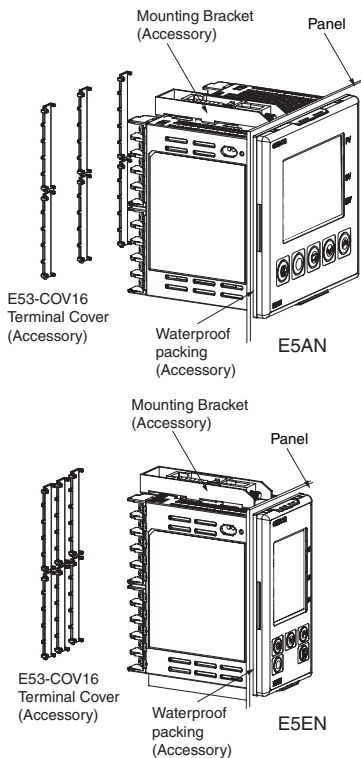

1. Insert the E5AN/E5EN into the square mounting hole in the panel (thickness: 1 to 8 mm). Attach the Mounting Brackets provided with the product to the mounting grooves on the top and bottom surfaces of the rear case.
2. Use a ratchet to alternately tighten the screws on the top and bottom Mounting Brackets little by little to maintain balance, until the ratchet turns freely.

Mounting the Terminal Cover

E5CN

Make sure that the "UP" mark is facing up, and then attach the E53-COV17 Terminal Cover to the holes on the top and bottom of the Temperature Controller.

E5AN/E5EN

Slightly bend the E53-COV16 Terminal Cover to attach it to the terminal block as shown in the following diagram. The Terminal Cover cannot be attached in the opposite direction.

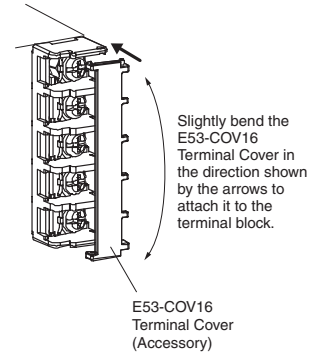

Removing the Temperature Controller from the Case

The Temperature Controller can be removed from the case to perform maintenance without removing the terminal leads. This is possible for only the E5CN, E5AN, and E5EN, and not for the E5CN-U. Check the specifications of the case and Temperature Controller before removing the Temperature Controller from the case.

E5CN

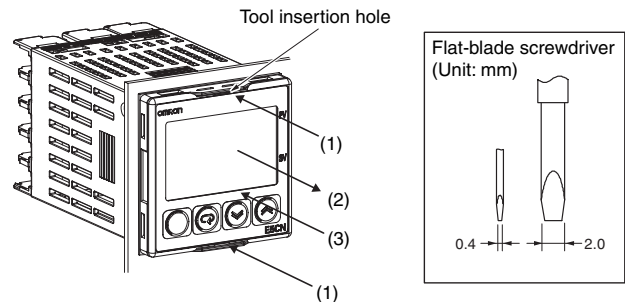

1. Insert a flat-blade screwdriver into the two tool insertion holes (one on the top and one on the bottom) to release the hooks.
2. Insert the flat-blade screwdriver in the gap between the front panel and rear case, and pull out the front panel slightly. Hold the top and bottom of the front panel and carefully pull it out toward you, without applying unnecessary force.
3. When inserting the body of the Temperature Controller into the case, make sure the PCBs are parallel to each other, make sure that the sealing rubber is in place, and press the E5CN toward the rear case into position. While pushing the E5CN into place, push down on the hooks on the top and bottom surfaces of the rear case so that the hooks are securely locked in place. Be sure that electronic components do not come into contact with the case.

E5AN/E5EN

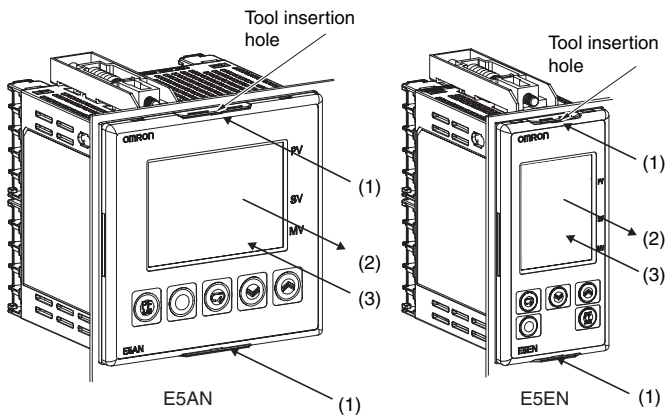

1. Insert a flat-blade screwdriver into the two tool insertion holes (one on the top and one on the bottom) to release the hooks.
2. Insert the flat-blade screwdriver in the gap between the front panel and rear case (two on the top and two on the bottom), and use it to pry and pull out the front panel slightly. Then, pull out on the front panel gripping both sides. Be sure not to impose excessive force on the panel.
3. When inserting the body of the Temperature Controller into the case, make sure the PCBs are parallel to each other, make sure that the sealing rubber is in place, and press the E5AN/E5EN toward the rear case until it snaps into position. While pressing the E5AN/E5EN into place, press down on the hooks on the top and bottom surfaces of the rear case so that the hooks securely lock in place. Make sure that electronic components do not come into contact with the case.

Precautions when Wiring

- Separate input leads and power lines in order to prevent external noise.
- Use wires with a gage of AWG24 (cross-sectional area: 0.205 mm²) to AWG14 (cross-sectional area: 2.081 mm²) twisted-pair cable (stripping length: 5 to 6 mm).
- Use crimp terminals when wiring the terminals.
- Tighten the terminal screws to a torque of 0.74 to 0.90 N·m, however the terminal screws on the E5CN-U must be tightened to a torque of 0.5 N·m.
- Use the following types of crimp terminals for M3.5 screws.



- Do not remove the terminal block. Doing so will result in malfunction or failure.

E5CN
E5CN-U (48 x 48 mm)

E5AN (96 x 96 mm)
E5EN (48 x 96 mm)

E5CN-H (48 x 48 mm)

E5AN-H (96 x 96 mm)
E5EN-H (48 x 96 mm)

Operation

Safety Precautions

CX-Thermo Support Software Ver. 4.0

EST2-2C-MV4

Monitoring/Setting Support Software for E5CN/CN-H, E5AN/AN-H, E5EN/EN-H, E5ZN, E5□R/□R-T, and EJ1 Temperature Controllers Enabling Faster Parameter Setup, Device Adjustment, and Maintenance

CX-One

- Enables editing and batch-downloading parameters from a personal computer, reducing the work required to set parameters. Usability is improved with table-formatted parameter editing from version. 4.0.
 - Supports Trend Monitoring: Monitor data (PV,SP,MV,PID parameter, Alarm ON/OFF, etc.) for up to 31 E5□N/□N-H Temperature Controllers. Connect up to 64 EJ1N, 17 EJ1G, or 16 E5ZN Temperature Controllers. (The Temperature Controllers must be from the same series.)
 - Supports parameter masks to hide parameters unnecessary to display. (Supported only by the E5□N/□N-H and E5□R/□R-T).
 - Logic operations enable setting inputs from external inputs (event inputs) or temperature status, outputs to external outputs (control or auxiliary outputs), and changing operating status with ON/OFF delays. (Supported only by the E5□N/□N-H).
 - Easy adjustment of control performance by fine-tuning.
- * Fine-tuning instructs the CX-Thermo to calculate a PID parameters by directly inputting commands to improve response.

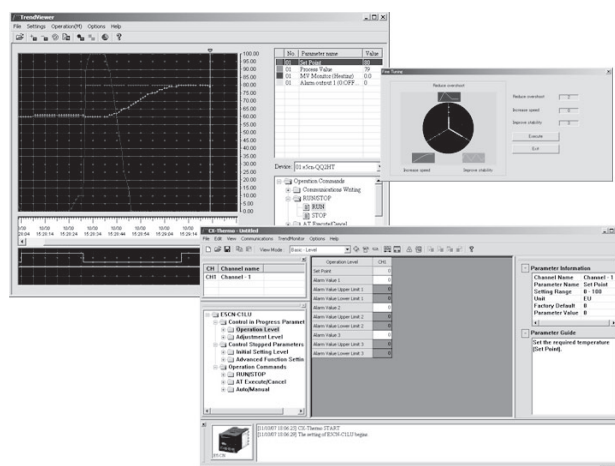

NEW

Ordering Information

List of Models

Name	Model
CX-Thermo Support Software	EST2-2C-MV4

Specifications

Compatible devices	Temperature Controllers	E5CN (available from April 2004) E5AN, E5EN (available from Feb 2005), E5CN-H, E5AN-H, E5EN-H E5AR, E5ER E5AR-T, E5ER-T E5ZN EJ1N-TC4, EJ1N-TC2, EJ1N-HFU EJ1G-TC4, EJ1G-TC2, EJ1G-HFU G3ZA (only when connected to EJ1N-TC4, EJ1N-TC2, EJ1G-TC4, EJ1G-TC2) Note: Models with DeviceNet communications are not supported.
Personal computer system requirements	OS	Windows 2000 (service pack 3 or higher), XP, or Vista (Japanese or English version)
	CPU	300 MHz min.
	Memory	128 MB min.
	Harddisk	300 MB min. available space
	CD-ROM	One CD-ROM drive min.
Connection method	Monitor	SVGA (800 × 600) min.
	Communications ports	<ul style="list-style-type: none"> • RS-232C port, or USB port, 1 port min.
Connection method		<ul style="list-style-type: none"> • An E58-CIFQ1 USB-Serial Conversion Cable is required to connect a computer to the setup tool port the E5□N, E5□N-H, or EJ1. • A K3SC Interface Converter is used to connect a computer to models with RS-422/RS-485 communications. • An E58-CIFIR USB-Infrared Conversion Cable is required to wirelessly connect a computer to models with infrared communications (E5AN-H or E5EN-H).

Warranty and Application Considerations

Read and Understand This Catalog

Please read and understand this catalog before purchasing the products. Please consult your OMRON representative if you have any questions or comments.

Warranty and Limitations of Liability

WARRANTY

OMRON's exclusive warranty is that the products are free from defects in materials and workmanship for a period of one year (or other period if specified) from date of sale by OMRON.

OMRON MAKES NO WARRANTY OR REPRESENTATION, EXPRESS OR IMPLIED, REGARDING NON-INFRINGEMENT, MERCHANTABILITY, OR FITNESS FOR PARTICULAR PURPOSE OF THE PRODUCTS. ANY BUYER OR USER ACKNOWLEDGES THAT THE BUYER OR USER ALONE HAS DETERMINED THAT THE PRODUCTS WILL SUITABLY MEET THE REQUIREMENTS OF THEIR INTENDED USE. OMRON DISCLAIMS ALL OTHER WARRANTIES, EXPRESS OR IMPLIED.

LIMITATIONS OF LIABILITY

OMRON SHALL NOT BE RESPONSIBLE FOR SPECIAL, INDIRECT, OR CONSEQUENTIAL DAMAGES, LOSS OF PROFITS, OR COMMERCIAL LOSS IN ANY WAY CONNECTED WITH THE PRODUCTS, WHETHER SUCH CLAIM IS BASED ON CONTRACT, WARRANTY, NEGLIGENCE, OR STRICT LIABILITY.

In no event shall the responsibility of OMRON for any act exceed the individual price of the product on which liability is asserted.

IN NO EVENT SHALL OMRON BE RESPONSIBLE FOR WARRANTY, REPAIR, OR OTHER CLAIMS REGARDING THE PRODUCTS UNLESS OMRON'S ANALYSIS CONFIRMS THAT THE PRODUCTS WERE PROPERLY HANDLED, STORED, INSTALLED, AND MAINTAINED AND NOT SUBJECT TO CONTAMINATION, ABUSE, MISUSE, OR INAPPROPRIATE MODIFICATION OR REPAIR.

Application Considerations

SUITABILITY FOR USE

OMRON shall not be responsible for conformity with any standards, codes, or regulations that apply to the combination of products in the customer's application or use of the products.

Take all necessary steps to determine the suitability of the product for the systems, machines, and equipment with which it will be used.

Know and observe all prohibitions of use applicable to this product.

NEVER USE THE PRODUCTS FOR AN APPLICATION INVOLVING SERIOUS RISK TO LIFE OR PROPERTY WITHOUT ENSURING THAT THE SYSTEM AS A WHOLE HAS BEEN DESIGNED TO ADDRESS THE RISKS, AND THAT THE OMRON PRODUCTS ARE PROPERLY RATED AND INSTALLED FOR THE INTENDED USE WITHIN THE OVERALL EQUIPMENT OR SYSTEM.

Disclaimers

PERFORMANCE DATA

Performance data given in this catalog is provided as a guide for the user in determining suitability and does not constitute a warranty. It may represent the result of OMRON's test conditions, and the users must correlate it to actual application requirements. Actual performance is subject to the OMRON *Warranty and Limitations of Liability*.

CHANGE IN SPECIFICATIONS

Product specifications and accessories may be changed at any time based on improvements and other reasons. Consult with your OMRON representative at any time to confirm actual specifications of purchased product.

DIMENSIONS AND WEIGHTS

Dimensions and weights are nominal and are not to be used for manufacturing purposes, even when tolerances are shown.

ALL DIMENSIONS SHOWN ARE IN MILLIMETERS.

To convert millimeters into inches, multiply by 0.03937. To convert grams into ounces, multiply by 0.03527.

Cat. No. H160-E1-01A In the interest of product improvement, specifications are subject to change without notice.

OMRON Corporation

Industrial Automation Company

Control Devices Division H.Q.

Analog Controller Division

Shiokoji Horikawa, Shimogyo-ku,

Kyoto, 600-8530 Japan

Tel: (81)75-344-7080/Fax: (81)75-344-7149

0208 (1207)